



# User Manual

**X100PADS Auto Key Programmer**

**Shenzhen Xtooltech Intelligent Co., LTD**

Version 1.2 | 2025.8

Please read this user manual carefully before using the Auto Key programmer, referred to as the “Scan Tool” throughout this document. When reading the manual, please pay attention to the words “Note” or “Caution”, and read them carefully for appropriate operation.

## **OPERATION INSTRUCTIONS**

For safe operation, please follow the instructions below:

- Keep the device away from heat or fumes when in use.
- If the vehicle battery contains acid, please keep your hands and skin or fire sources away from the battery during testing.
- The exhaust gas of the vehicle contains harmful chemicals. Please ensure adequate ventilation.
- Do not touch the vehicle cooling system components or exhaust manifolds when the engine is running due to the high temperatures reached.
- Make sure the car is securely parked, Neutral is selected or the selector is at the P or N position to prevent the vehicle from moving when the engine starts.
- Make sure the (DLC) Diagnostic Link Connector is functioning properly before starting the test to avoid damage to the Diagnostic Computer.
- Do not switch off the power or unplug the connectors during testing.
- Doing so may damage the ECU (Electronic Control Unit) and/or the Diagnostic Computer.

## **CAUTIONS!**

- Avoid shaking, dropping or dismantling the scan tool as it may damage the internal components.
- Use only your fingertips to touch the LCD screen. Hard or sharp objects may damage the scan tool.
- Do not use excessive force;
- Do not expose the screen to strong sunlight for a long period.
- Please keep the scan tool away from water and moisture.
- Store and use the scan tool only within the temperature ranges identified in the Technical Specifications section.
- Keep the unit away from strong magnetic fields.

## **AFTERSALES-SERVICES**

E-Mail: [supporting@xtooltech.com](mailto:supporting@xtooltech.com)

Tel: +86 755 21670995 or +86 755 86267858 (China)

Official Website: [www.xtooltech.com](http://www.xtooltech.com)

# Catalogue

Operation Instructions .....	1
Cautions! .....	1
1. General Introduction.....	3
2. Diagnostics .....	4
3. Special Functions .....	16
3.2 OIL RESET .....	19
3.3 EPB .....	21
3.4 SAS .....	23
3.5 BMS RESET .....	25
3.5 INJECTOR CODING .....	26
3.7 DPF REGENERATION .....	29
3.8 TPMS RESET .....	32
4. Report .....	36
5. Update & Factory Reset.....	39
6. Remote Assistance .....	41
7. Appendix.....	42
8.Key Programming.....	43

# General Introduction

The X100PADS Auto Key Programmer is a professional key programming device, based on the Android operating system. It supports multi-language switching and is suitable for different countries and regions.

## TABLET

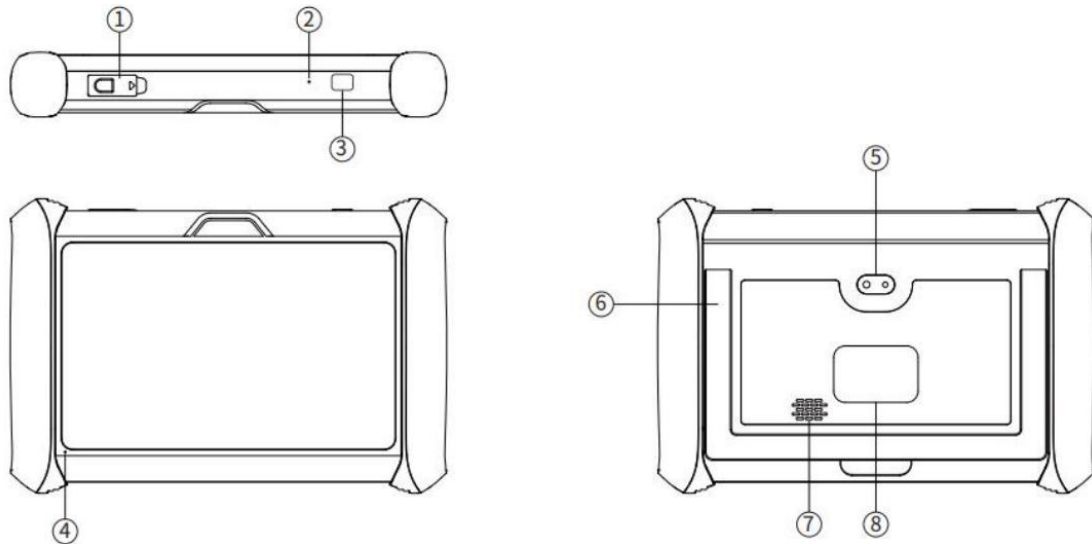

- ① Type-C Port
- ② Reset Hole
- ③ Power Button
- ④ Microphone
- ⑤ Camera
- ⑥ Tablet Holder
- ⑦ Speaker
- ⑧ Nameplate

## VEHICLE CONNECTION

- Press and hold the Power button to turn on the tablet
- Select App language and start the activation
- Follow the hints to complete the activation

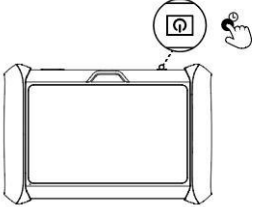

**1**

- Connect the main cable to the tablet and tighten the screws

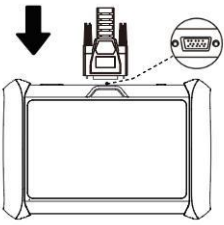

**2**

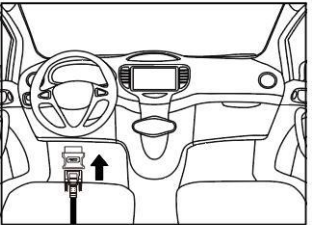

- Plug the DB15 main cable into the vehicle's DLC port via OBD2-16 adapter

**3**

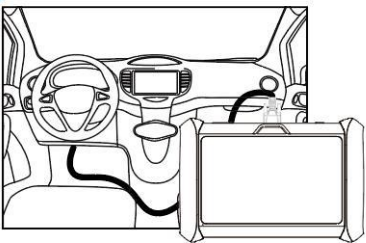

- Your tablet is now ready

**4**

## **Precautions for Diagnosis**

1. The voltage range on the car: +9~+36V DC;
2. When testing some special functions, the operator must operate according to the prompts and meet the test conditions. For some models [special functions], the conditions that need to be met are: engine water temperature 80 °C~105 °C, turn off headlights and air conditioners, keep the accelerator pedal in the released position, etc.;
3. The electronic control systems of different models are very complicated. If you encounter situations where it is impossible to test or a large amount of test data is abnormal, you can search for the ECU of the vehicle and select the menu for the model on the ECU nameplate;
4. If the vehicle type or electronic control system to be tested is not found in the diagnostic function, please upgrade the vehicle diagnostic software to the latest version using the Updates menu or consult the XTOOL technical service department;
5. Only wiring harnesses provided by XTOOL and designed for the device are permitted to be used with this device to avoid damage to the vehicle or the device;
6. When running a Diagnostics function, it is forbidden to shut down the device directly. You should cancel the task before returning to the main interface and then shutting down the device.

## **2. DIAGNOSTICS**

The diagnostic function can read ECU information, read and clear DTC (Diagnostic Trouble Codes) and check live data and freeze frame data. The Diagnostic application can access the ECU of various vehicle control systems, including the Engine, Transmission, Anti-lock Braking System (ABS), Airbag Safety Restraing System (SRS), Electronic Parking Brake system (EPB) and perform many types of actuation tests.

### **BEGINNING DIAGNOSTIC TESTING**

After the tablet device is properly connected to the vehicle, you could start the vehicle diagnosis.

# VEHICLE SELECTION

The scan tool supports the following 3 ways to access the smart diagnostics system.

- **AUTO SCAN**
- **MANUAL INPUT**
- **SELECT VEHICLE BY AREA**

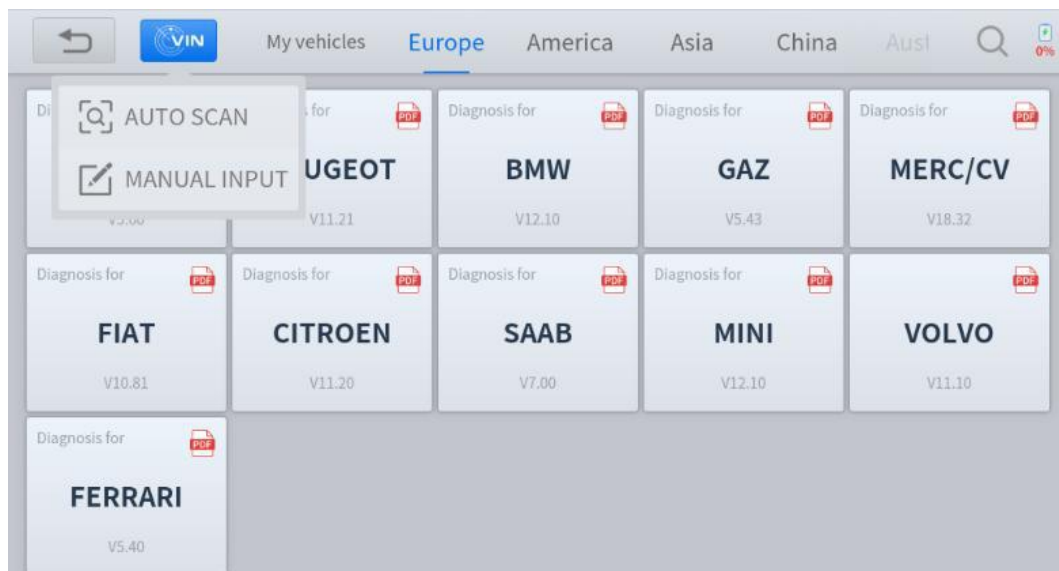

Click the VIN button in the upper left corner and then choose to enter the vehicle diagnosis through either **AUTO SCAN** or **MANUAL INPUT**.

**AUTO SCAN:** It supports the automatic reading of vehicle VIN code. You also can tap on the button “AUTO SCAN” on the diagnosis system entrance to use this function. Please make sure that the car and the device are well connected before using this function.

**⚠ If your model is not recognized, please try the following steps:**

- ① UPDATE all software, and check whether the APP is updated in [Settings]**
- ② Please click Diagnosis on the main menu to enter the selection menu, manually select the engine system to read the ECU information, and confirm whether the VIN can be read.**
- ③ Contact the XTOOL technical team to provide the VIN code to confirm whether the model supports automatic identification of VIN.**

**MANUAL ENTER:** It supports manual input of car VIN code. When entering the VIN code manually, make sure that the 17 characters entered are correct to ensure accurate test results.

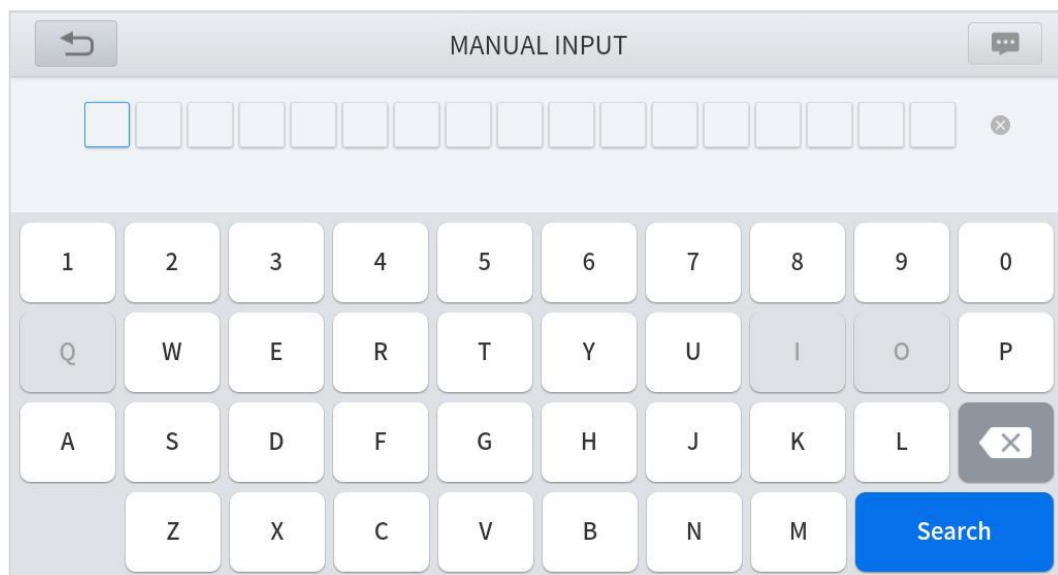

- **SELECT VEHICLE BY AREA**

In addition to the above 3 methods, you can also choose a car brand by selecting the appropriate region at the top of the screen. You can select the vehicle model that needs to be diagnosed according to the area, as shown below:

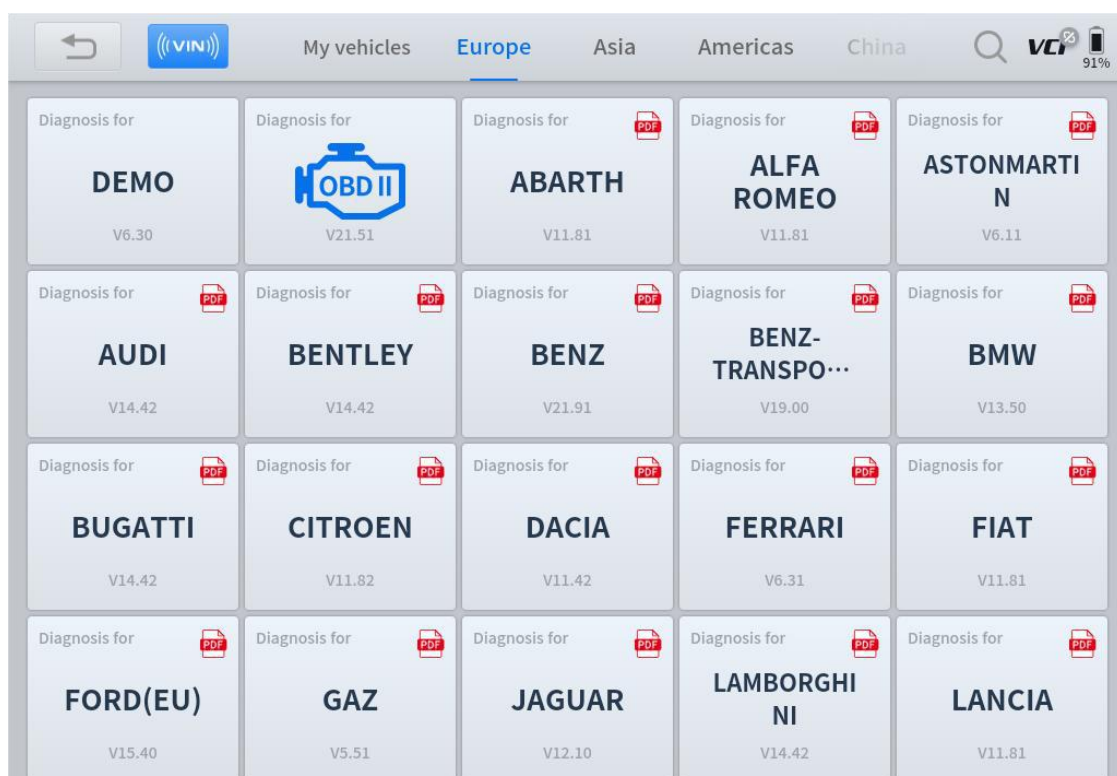

**OBD-II** supports reading the related fault codes of the Powertrain Control Module (PCM).

**DEMO:** a demonstration program; Click this button to experience and learn the operation processes of the diagnostic function.

Some models provide multiple entry methods in the sub-menu, including:

- Automatic Detection
- Manual Selection
- System Selection

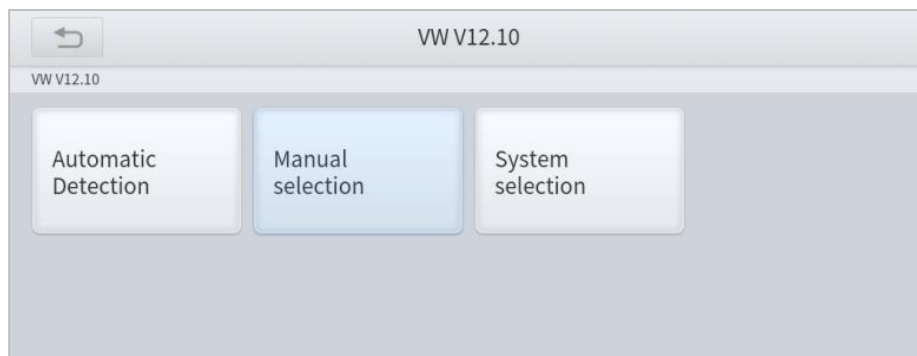

**Automatic Detection:** Will automatically identify the vehicle's VIN code, and then read the information of your target diagnostic object. If you choose "**Manual selection**", then you can continue to select the vehicle brand, year, and model of the vehicle in the sub-menu to diagnose the vehicle. Enter "**System Selection**", you can also diagnose the vehicle according to the system according to your needs after selecting the model.

## DIAGNOSIS FUNCTIONS

Diagnostics functions supported by the scan tool are listed below:

- **Read ECU Information**
- **Read/Clear Trouble Code**
- **Read Live Data**
- **Freeze Frame**



- **Read ECU Information**

This function is to read ECU version information and is the equivalent of "**System Identification**" or "**System Information**" in some electronic control systems. These equivalent terms all refer to reading ECU-related software and hardware versions, models and production date of diesel engines, part numbers, etc. This information is helpful when recording maintenance records and ordering new parts.

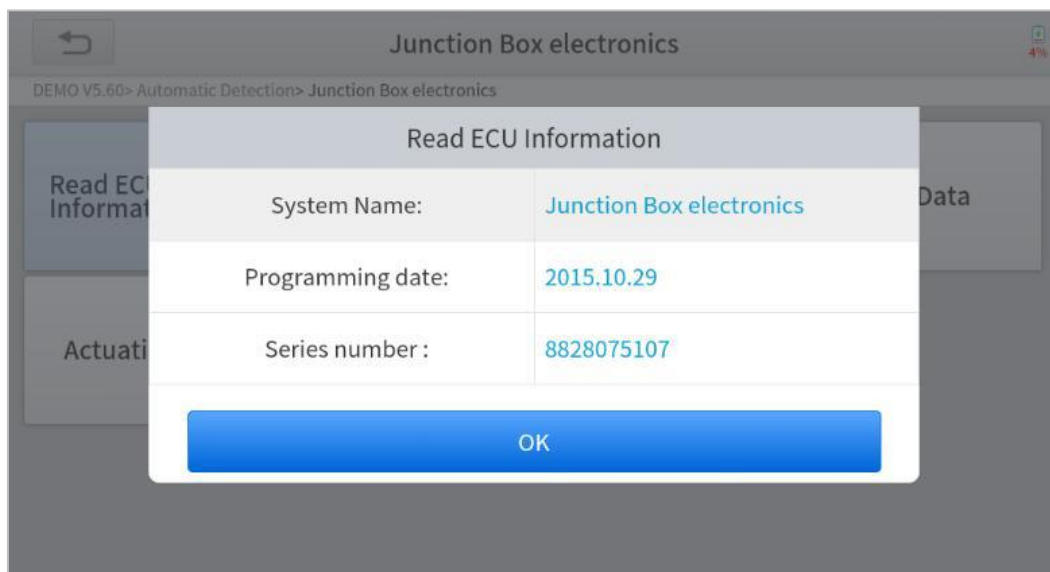

- **Read Trouble Code**

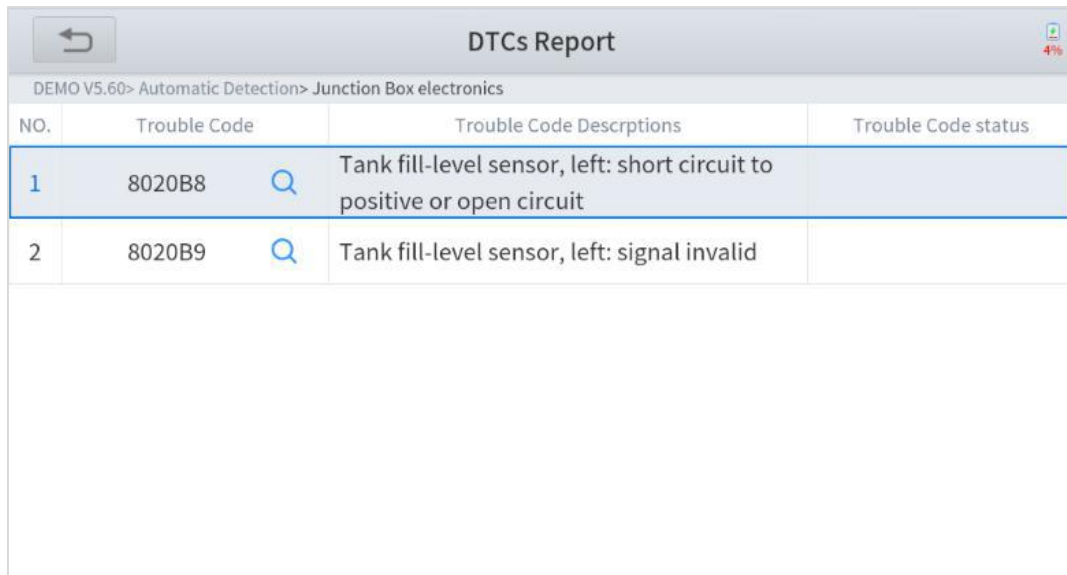

DTCs Report			
DEMO V5.60> Automatic Detection> Junction Box electronics			
NO.	Trouble Code	Trouble Code Descriptions	Trouble Code status
1	8020B8	Tank fill-level sensor, left: short circuit to positive or open circuit	
2	8020B9	Tank fill-level sensor, left: signal invalid	

In the process of diagnosis, if the device shows “System is OK” or “No Trouble Code”, it means there is no related trouble code stored in ECU or some troubles are not under the control of ECU.

Most troubles are mechanical system troubles or executive circuit troubles. It is also possible that the signal of a sensor may be inaccurate but within limits, which can be examined using Live Data.

- **Clear Trouble Code**

It allows for clearing current and historical trouble codes stored in the ECU memory, under the premise that all the troubles have been resolved.



Some troubles are immediately detected by the ECU with the key in the run position and without the engine running. Other troubles are not detected until very specific test conditions are met such as engine coolant temperature within a range, speed within a range for a duration of time, throttle percentage within a range, etc.

If the trouble codes are erased when the trouble remains unresolved, the trouble code will reappear in the ECU the next time the ECU performs the specific diagnostic test for that trouble.

If the trouble is resolved but there is a stored trouble code, sometimes the ECU will detect the resolution and clear the trouble code or more likely, classify it as “historical” trouble.

If the trouble is resolved and the user clears the trouble codes, the trouble history will be cleared.

If the user intends to have another colleague or mechanic investigate the problem, it is not recommended for the user to clear the trouble code since doing so may erase information helpful to others who may investigate the issue.

## ● Read Live Data

Real-time information about various sensors is called “Live Data”. Live Data includes **parameter identifications (PIDs)** of the running engine such as oil pressure, temperature, engine speed, fuel oil temperature, coolant temperature, intake air temperature, etc. Based on these parameters, we can predict directly where the problem lies, which helps to narrow the scope of maintenance. For some vehicles, during their actual operation, the problems such as performance characteristics or sensitivity reduction, can be evaluated using live data.

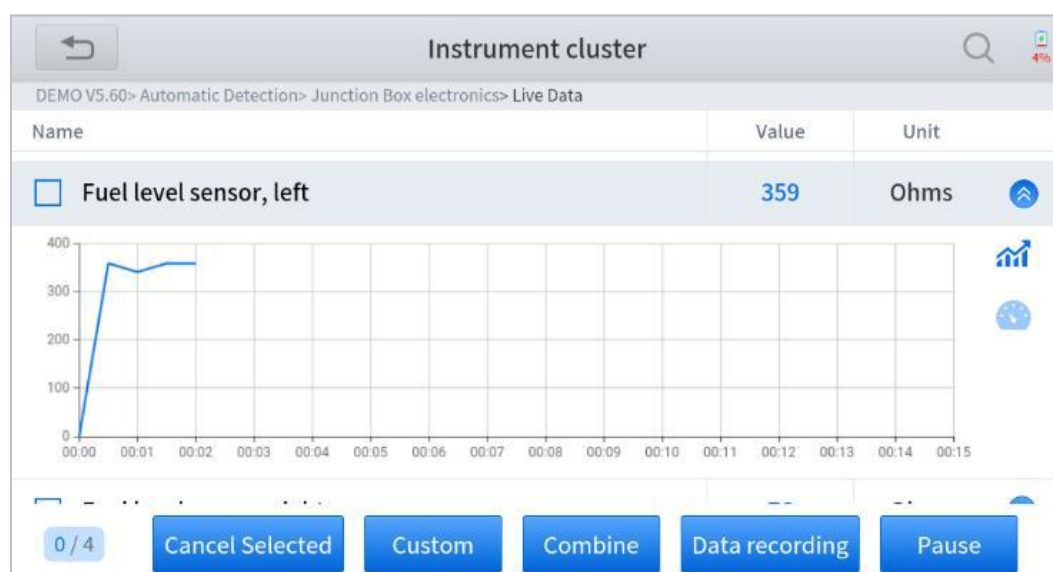

Click the magnifying glass on the top right, you can search for related PIDs based on keywords

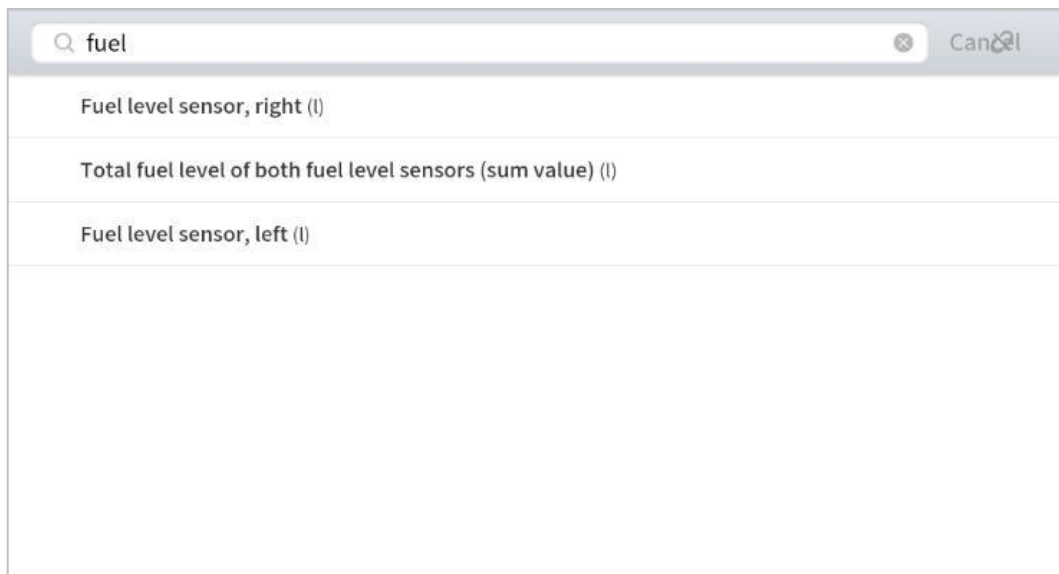

- **Custom**

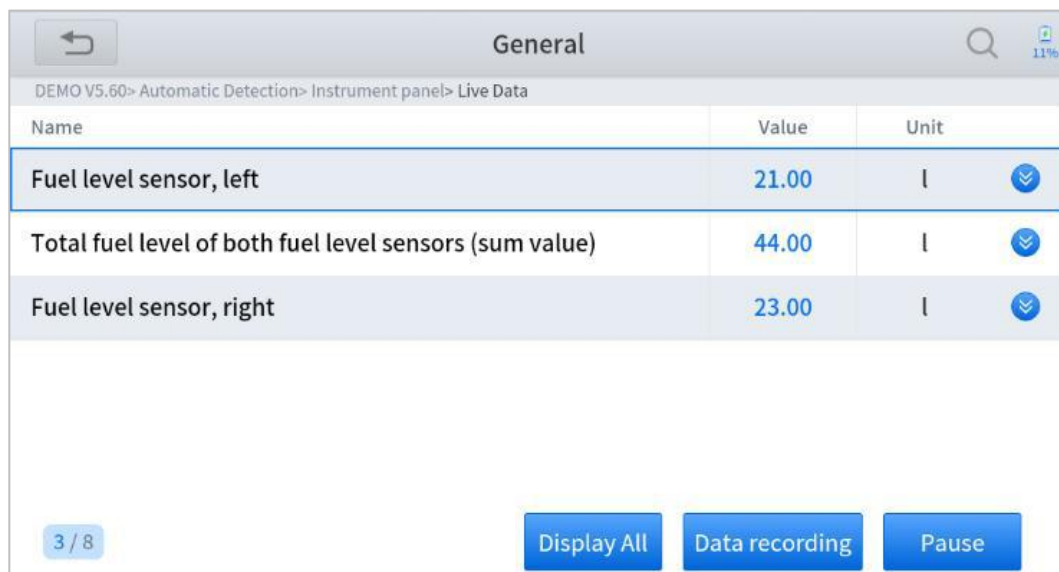

The scan tool includes support to select and show multiple PIDs. Click **Display All** to display all PIDs

- **Combine**

The scan tool includes support to select multiple PIDs and click *Combine* to combine different graphs into one chart.

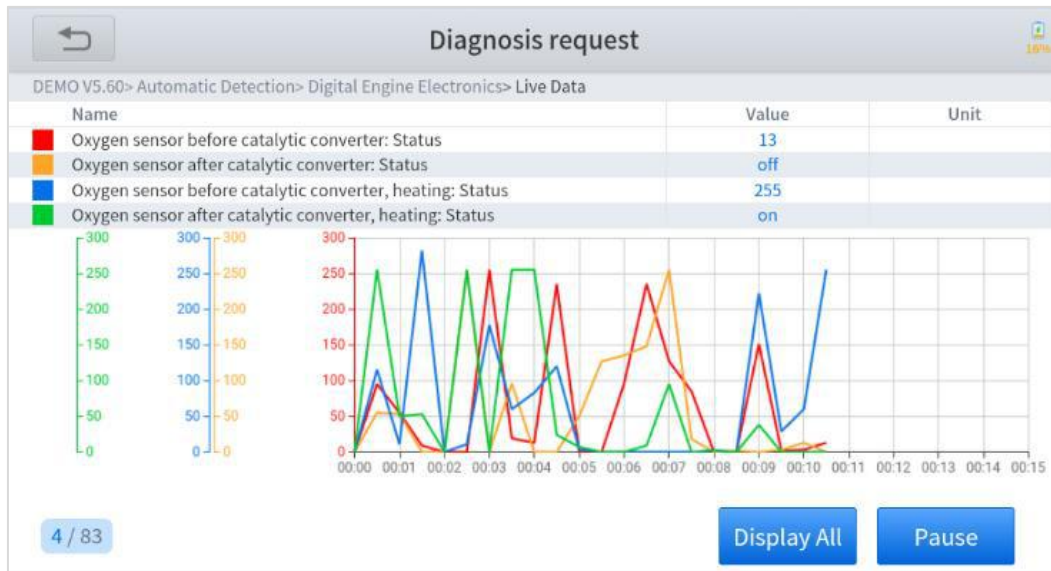

- **Data recording**

The scan tool supports recording the current data values in the form of text. You can view the recorded files in *Reports->Data Replay*.

The screenshot shows the 'General' window with a list of parameters for data recording. A blue notification bar at the top states 'Data recording is turned on, press again to end data recording'. The table below lists parameters with checkboxes, current values, and units.

Name	Value	Unit
<input type="checkbox"/> Revolution counter	040	1/1000
<input type="checkbox"/> Outside temperature sensor	50.00	deg C
<input type="checkbox"/> Total distance (absolute value)	40356	km
<input checked="" type="checkbox"/> Fuel level sensor, right	23.00	l
<input checked="" type="checkbox"/> Total fuel level of both fuel level sensors (sum value)	44.00	l
<input checked="" type="checkbox"/> Fuel level sensor, left	21.00	l

The interface includes a '3 / 8' indicator and buttons for 'Cancel Selected', 'Custom', 'Combine', 'Data recording', and 'Pause'.

Name	Value	Unit
<input type="checkbox"/> Revolution counter	040	1/min
<input type="checkbox"/> Outside temperature sensor	50.00	deg C
<input type="checkbox"/> Total distance (absolute value)	40356	km
<input checked="" type="checkbox"/> Fuel level sensor, right	23.00	l
<input checked="" type="checkbox"/> Total fuel level of both fuel level sensors (sum value)	44.00	l
<input checked="" type="checkbox"/> Fuel level sensor, left	21.00	l

3 / 8    Cancel Selected    Custom    Combine    Data recording    Pause

- **Pause**

Click this button to pause the recording timeline

- **Freeze Frame**

When the signal of the sensor is abnormal, the ECU will save the data at that moment of failure to form a freeze-frame. It is usually used to analyze the reasons that may lead to component(?) failures.

The live data items supported by vehicles of different brands are not the same, so the freeze frames displayed when diagnosing vehicles of different brands may also be different. Some vehicles may not have the option of a freeze-frame which means that the model does not support this function.

Take **Renault Duster ii ph** as an example:

After selecting the system to enter the lower freeze frame menu, the device will list all the fault codes under the system.

Users can click on a fault code, such as **DF1068** to view the freeze frame recorded by the car when the fault code occurs, including context when the fault appeared, and current context and additional data.

Read trouble code		
RENAULT V9.93> Automatic Detection> Duster ii ph> System Selection> Injection		
DF1068	Refrigerant pressure sensor voltage	Current
DF887	Accelerator pedal position Fault on gangs 1 and 2 of the pedal potentiometer.	Current
DF974	Pedal potentiometer circuit track 1 Signal outside lower limit	Current
	Pedal potentiometer	
<a href="#">Read freeze frame</a>		

DF1068		
RENAULT V9.93> Automatic Detection> Duster ii ph> System Selection> Injection> DF1068		
<a href="#">Context when fault appeared</a>	<a href="#">Current context</a>	<a href="#">Additional data</a>

**Context when fault appeared:** record the live data when fault appeared to help the user to know the vehicle status. *\*Some vehicles don't support this function; users will get a prompt when they click the menu.*

**Current context:** Displays the current live data stream associated with the DTC

**Additional data:** record other data related to the fault

Additional data			
RENAULT V9.93> Automatic Detection> Duster ii ph> System Selection> Injection> DF1068			
NO.	Name	Value	Unit
1	Additional data:		
2	Mileage since fault last disappeared		km
3	Mileage since last appearance of fault		km
4	Number of occurrences of fault		
5	Distance when fault first occurred		km
6	Distance travelled with fault present		km
<a href="#">Save as reference</a> <a href="#">Data recording</a> <a href="#">Pause</a> <a href="#">Graph</a>			

### 3. SPECIAL FUNCTIONS

The H6Elite 2 supports a lot of commonly used special reset functions, allowing you to quickly access your vehicle system for various scheduled services, maintenance, and reset performance. These functions often eliminate the need to reset codes after resolving common problems. Since XTOOL is continuously developing, the manual may not include all of the latest special functions that are available for download. This user manual lists some of the commonly used special reset services for your reference.

- **ABS BLEEDING**

Anti-Lock Braking System keeps the tires from locking up immediately when there are brakes. Keeping ABS in good condition can give full play to the effectiveness of the brakes, shorten the braking time and distance, prevent the vehicle from skidding and tailing during emergency braking, ensure good driving stability and steering maneuverability, and avoid violent friction between the tires and the ground to reduce tire wear. When the ABS contains air, the ABS bleeding function must be performed to bleed the brake system to restore ABS brake sensitivity.

ABS Bleeding can be performed in the following cases:

- replace the rear brake distributor pump or the front brake distributor pump.
- Severe brake fluid shortage.
- change the brake fluid.

***The operation guidelines of the ABS Bleeding function are shown as below:***

1. Read the operating instructions and precautions that appear on the screen carefully before performing the operation to ensure that the equipment and car are in the correct condition.
2. Attach bleeder bottle to the left rear bleeder screw.
3. Open the left rear bleeder screw.

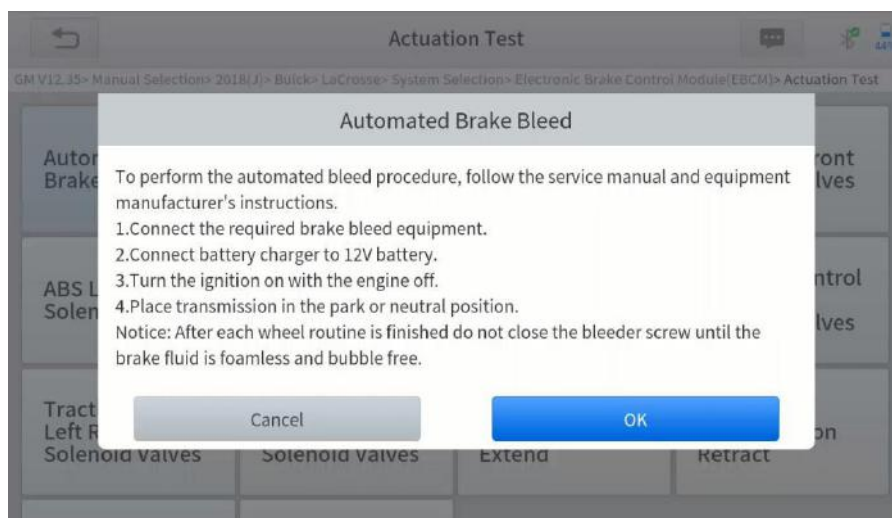

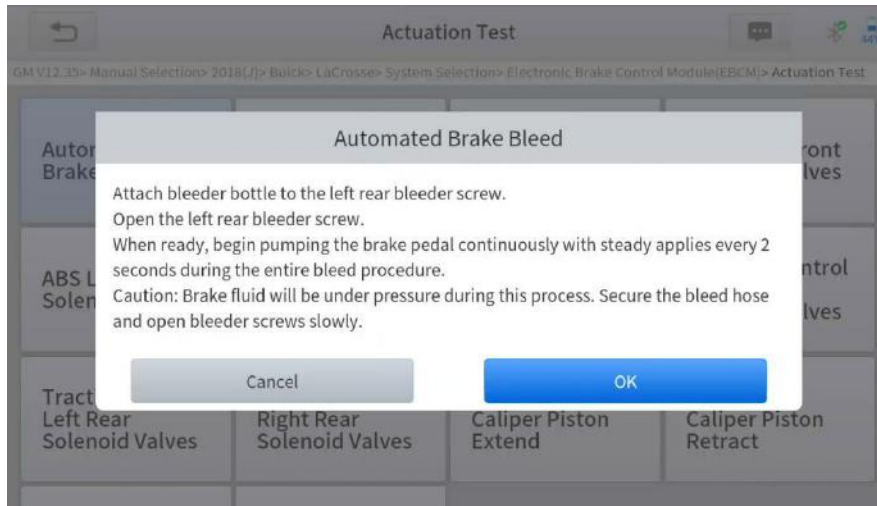

4. When ready, click " **OK** " to enter the bleed procedure, and pumping the brake pedal continuously with steady applies every 2 seconds during the entire procedure.

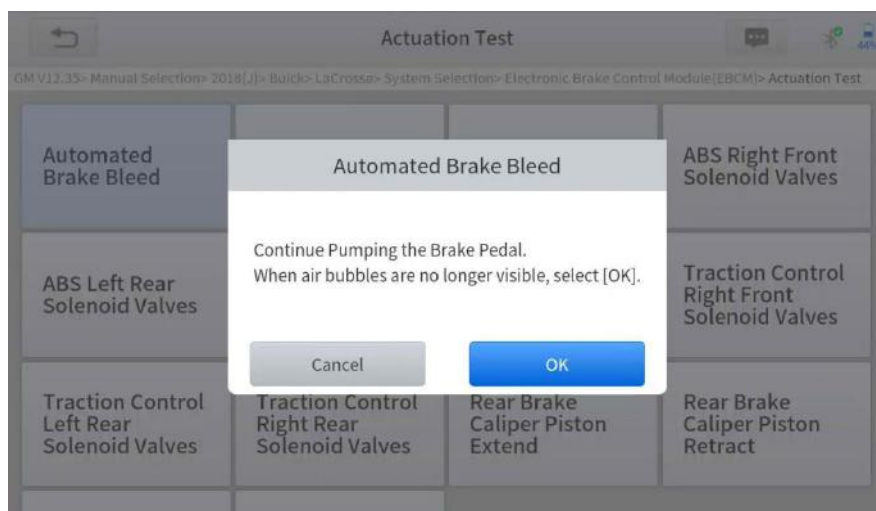
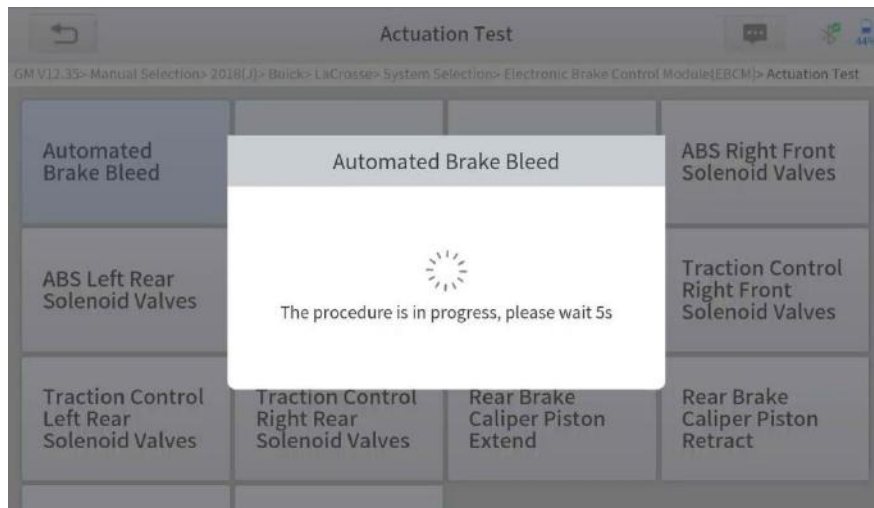

5. Continue pumping the brake pedal, when air bubbles are no longer visible, select " **OK** " to enter next bleed procedure for left front wheel.

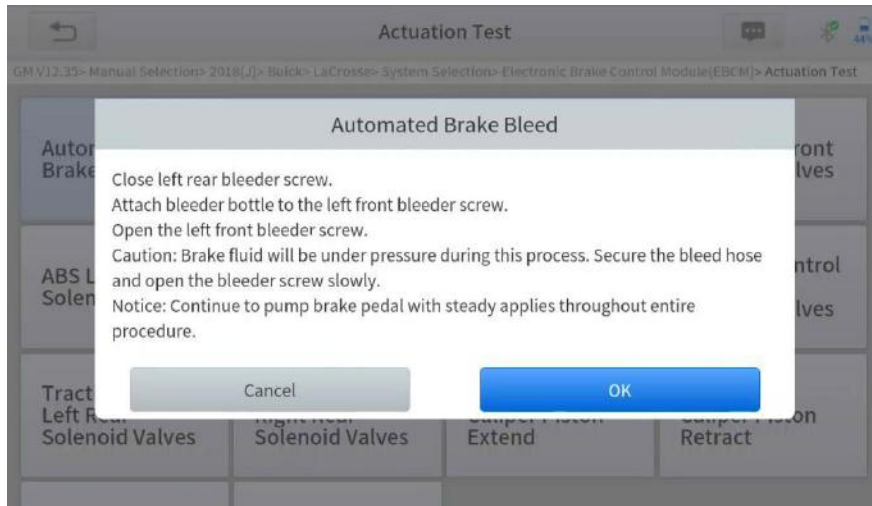

6. Repeat the operation 3 times to complete the bleed procedure for the left front wheel, right front wheel and right rear wheel in turn.

7. Stop pumping the brake pedal, and close the right rear bleeder screw.

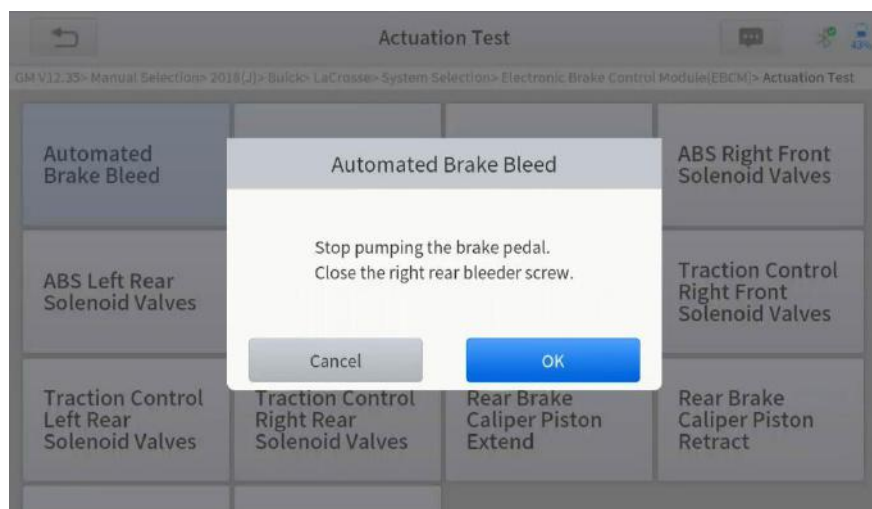

8. Click " **OK** " to complete the entire bleed procedure.

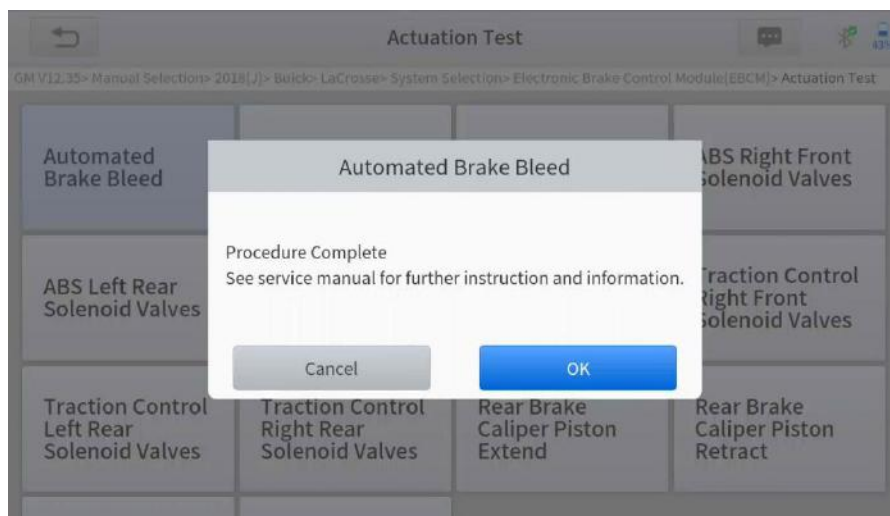

## Caution

- The ABS pump screw needs to be unscrewed.
- Brake fluid will be under pressure during this process. Secure the bleed hose and open bleeder screws slowly.
- Some vehicles do not support automatic bleeding, but manually bleeding.

## 3.2 OIL RESET

The scan tool can be used to reset the engine oil life system, which calculates the optimum oil life change interval based on the vehicle's driving conditions and climate. The oil life reminder must be reset each time the oil is changed so that the system can calculate when the next oil change is required.

This function can be performed in the following cases:

- If the service lamp is on, you must provide service for the car. After service, you need to reset the driving mileage or driving time so that the service lamp turns off and the system enables the new service cycle.
- After changing engine oil or electric appliances that monitor oil life, you need to reset the service lamp.

**The operation guidelines of the Oil Reset function are shown as below:**

1. Enter the **Oil Reset** menu and choose relevant models according to the vehicle being tested.
2. Follow the instructions displayed that are specific to the vehicle and press **OK** after completing the instructions shown.

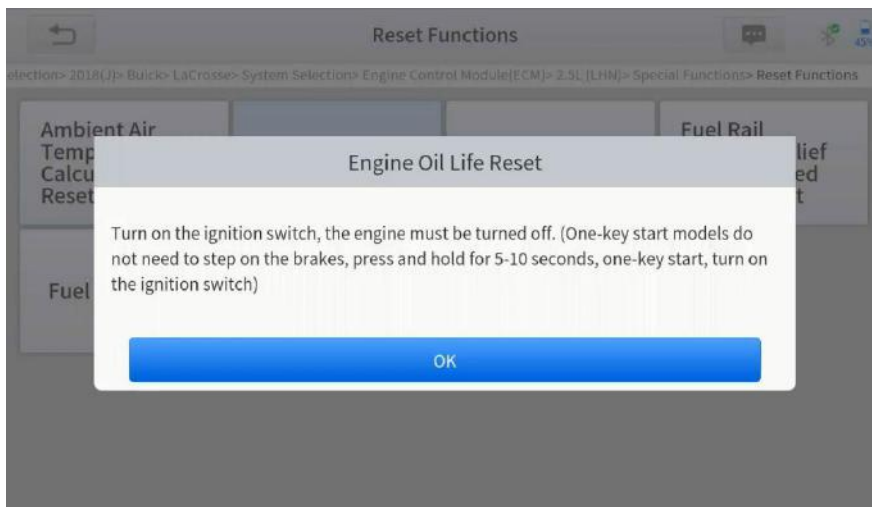

3. Enter Maintenance mileage reset menu.
4. Click **INPUT** and enter a reasonable value of remaining oil life and press **OK**.

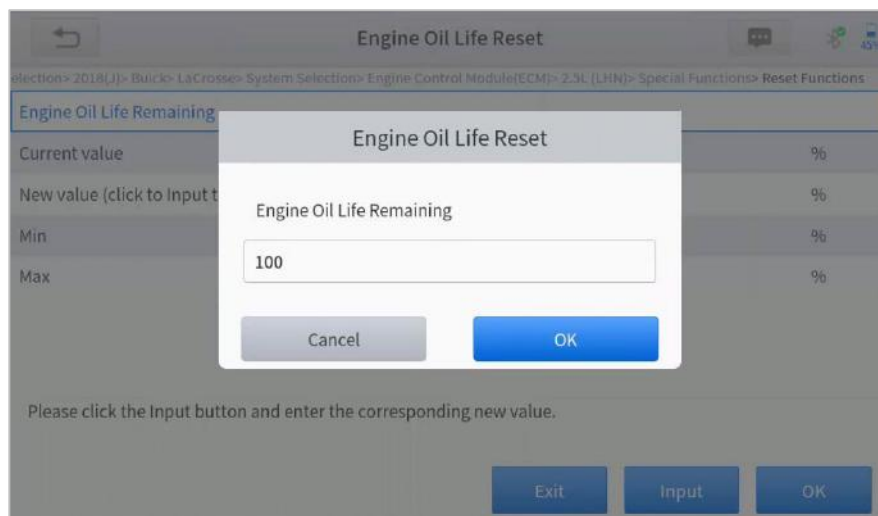

5. Confirm the [New Value] you just entered, and then click **OK** at the bottom right to complete the procedure.

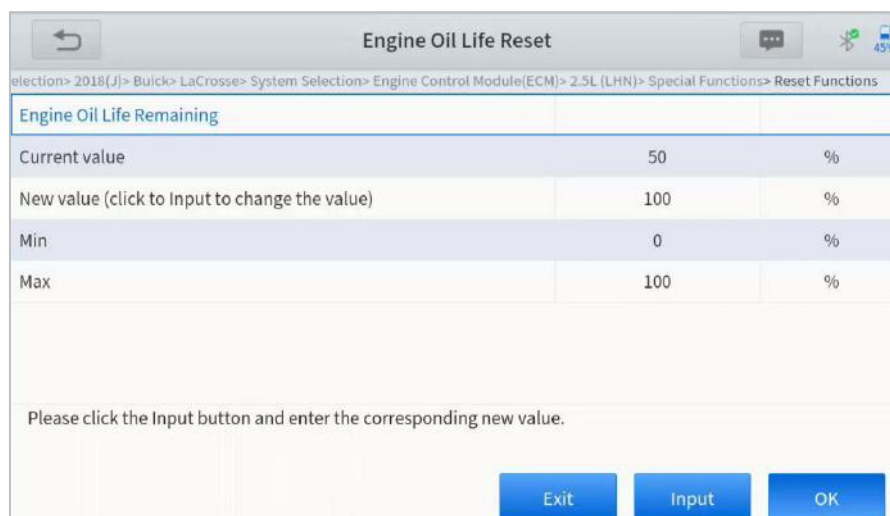

6. Message of 'Write successfully' displays when Oil Reset function has successfully performed.

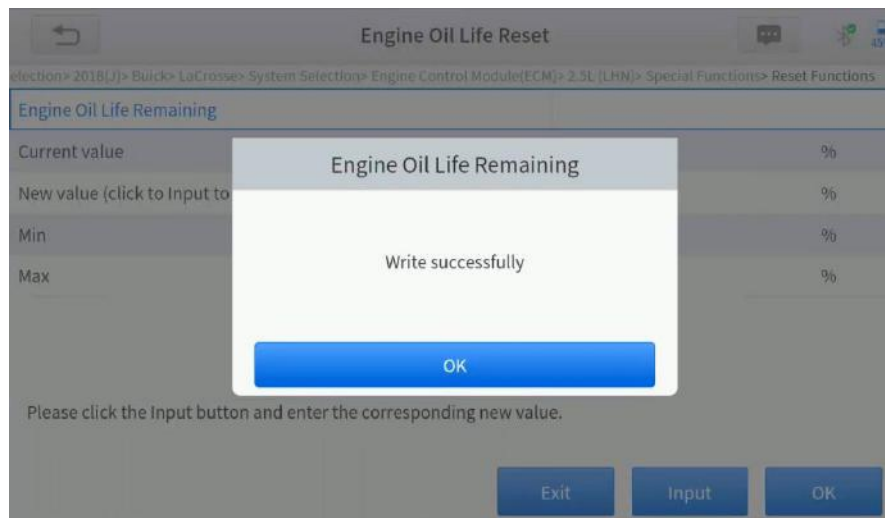

### 3.3 EPB

Electronic Parking Brake (EPB) System reset is a popular special function. You can use this function to reset the electronic parking brake system and brake pads (retraction, release of the brake pump), G-sensor and body angle calibration. This function has multiple uses and can safely and effectively maintain the electronic brake system. These applications include deactivating and activating brake control systems, assisting in controlling brake fluid, applying and releasing brake pads, setting brakes after replacing brake discs or brake pads, etc.

1. If the brake pad wears the brake pad sense line, the brake pad sense line will send a signal to the onboard tablet asking for replacing the brake pad. After replacing the brake pad, you must reset the brake pad to clear the trouble code. Otherwise, the car continues to falsely notify the user that the brake pads are in need of replacement.
2. A reset must be performed in the following cases:
  - The brake pad and brake pad wear sensor are replaced.
  - The brake pad indicator lamp is on.
  - The brake pad sensor circuit is shorted.
  - The servo motor is replaced.

*The operation guidelines of the EPB function are shown as below:*

1. Enter the **EPB** menu and choose relevant models according to the vehicle being tested.
2. Follow the instructions displayed and press **YES** after completing the instructions shown.

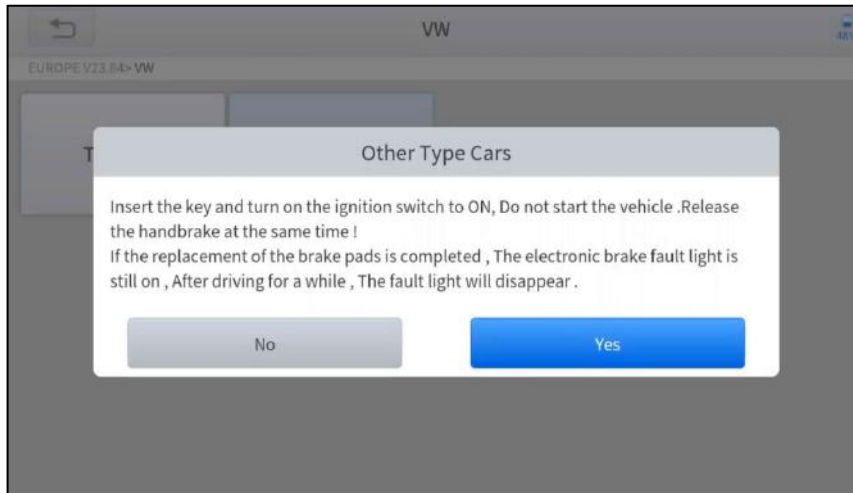

3. Enter the **Enter maintenance mode** menu and release the handbrake brake. And press **OK** after completing the instructions shown.

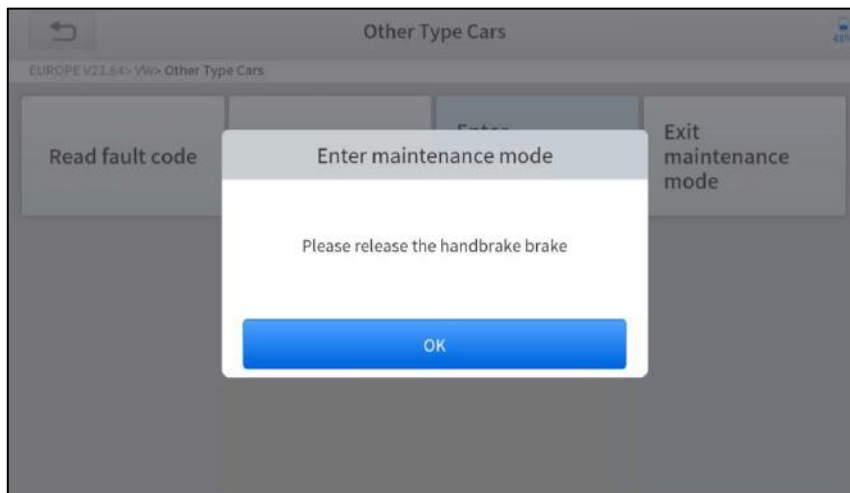

4. Wait until the message of '**Successful operation**' popes up. And press **OK** to exit the menu.
5. Enter the **Exit maintenance mode** menu and wait until the message of "**Successful operation** " popes up.

### 3.4 SAS

Steering Angle Sensors (SAS) System Calibration permanently stores the current steering wheel position as the straight-ahead position in the SAS EEPROM. Therefore, the front wheels and the steering wheel must be set exactly to the straight-ahead position before calibration. In addition, the VIN is also read from the instrument cluster and stored permanently in the SAS EEPROM. On successful completion of calibration, the SAS fault codes will be automatically cleared.

To reset the steering angle, you need to first find the relative zero point position for the car to drive in a straight line. Taking this position as a reference, the ECU can calculate the accurate angle for left and right steering.

After replacing the steering angle position sensor, replacing steering mechanical parts (such as steering gearbox, steering column, end tie rod, steering knuckle), performing four-wheel alignment, or repairing the car body, you must reset the steering angle.

*The operation guidelines of the SAS function are shown as below:*

1. Enter the **SAS** menu and choose relevant models according to the vehicle being tested.
2. Enter the **Set steering angle sensor** menu and follow the instructions displayed.

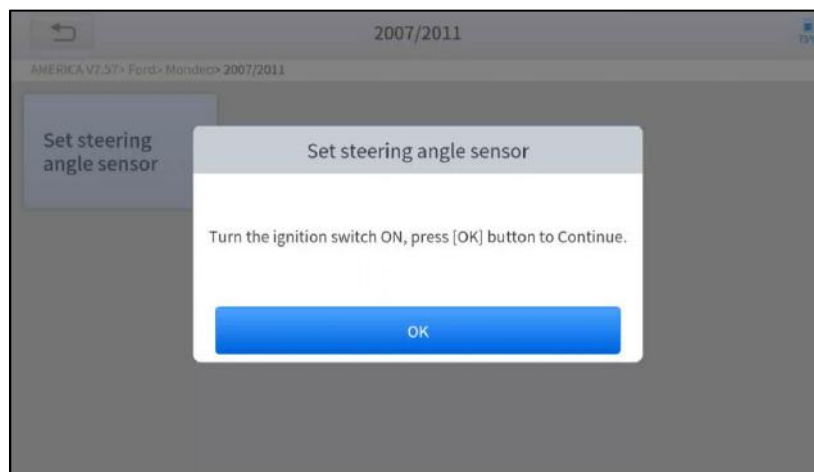

3. Wait until the following instruction is displayed and press **Yes** after completing the instructions shown.

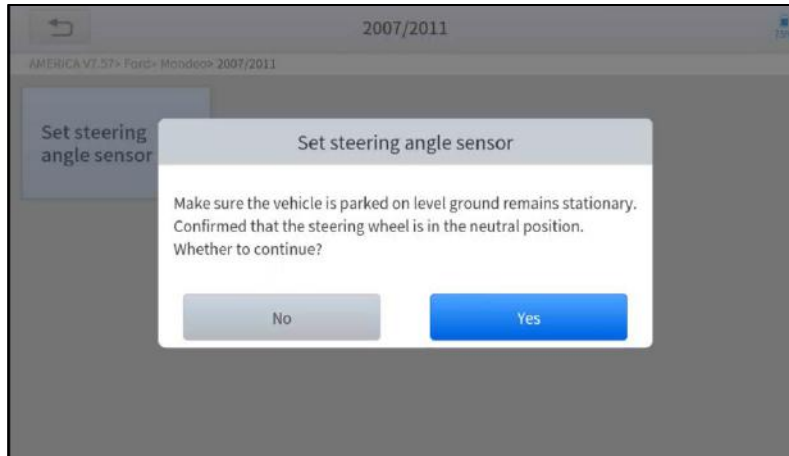

4. Follow the instructions displayed and press **OK** after completing the instructions shown.

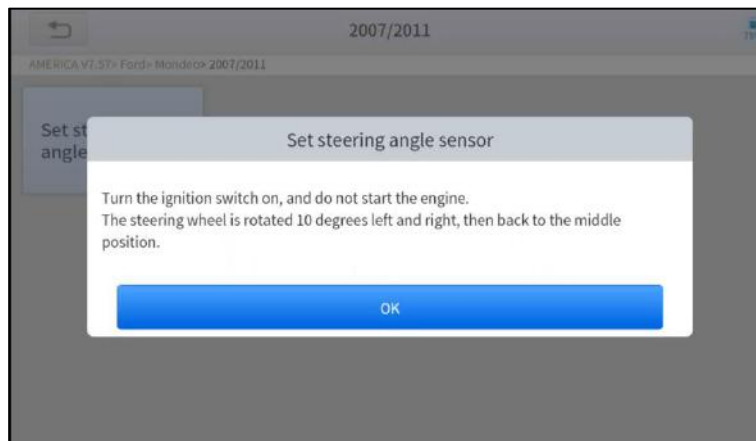

5. Wait until the following instruction is displayed and press **OK** after completing the instructions shown.

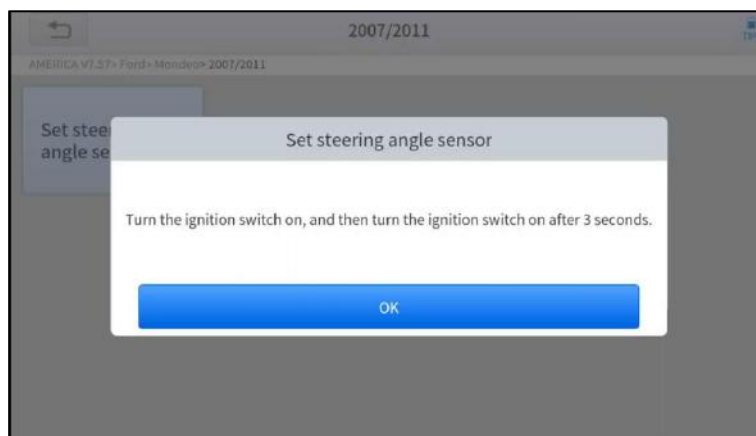

1. Message of '**Function execution is completed**' displayed when SAS reset function has successfully completed.

### 3.5 BMS RESET

The Battery Management System (BMS) allows the scan tool to evaluate the battery charge state, monitor the close-circuit current, register the battery replacement and activate the rest state of the vehicle.

This function enables you to perform a resetting operation on the monitoring unit of the vehicle battery, in which the original low battery fault information will be cleared and battery matching will be performed.

Battery matching must be performed in the following cases:

- The main battery is replaced. Battery matching must be performed to clear original low battery information and prevent the related control module from detecting false information. If the related control module detects false information, it will invalidate some electric auxiliary functions, such as automatic start & stop function, sunroof without one-key trigger function or power window without automatic function.
- Battery matching is performed to re-match the control module and motoring sensor to detect battery power usage more accurately, which can avoid an error message displayed on the instrument cluster.

*The operation guidelines of the BMS Reset function are shown as below:*

1. Enter the **BMS Reset** menu and choose relevant models according to the vehicle being tested.
2. Turn on the ignition switch.
3. Press **OK** to continue the BMS function.
4. Enter **battery capacity** (within the given range) and press **OK** after the input.



5. Enter the **battery manufacturer** and press **OK** after the input.

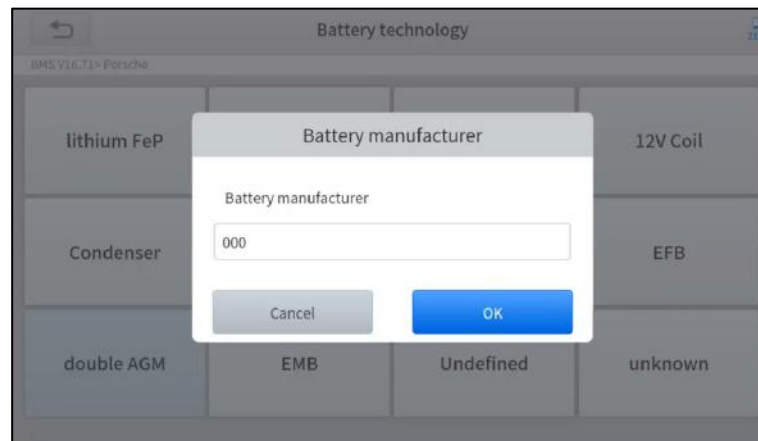

6. Enter the **10-digit battery serial number** and press **OK** after the input.



### 3.6 INJECTOR CODING

This function can write the identification code of the fuel injector into the ECU so that the ECU can recognize the new injector.

After the ECU or injector is replaced, the injector code of each cylinder must be confirmed or re-coded so that the cylinder can better identify injectors to accurately control fuel injection.

***ⓘ In general cases, there is no need to perform the coding matching function after cleaning;***

***ⓘ The identification of the fuel injector includes its working accuracy value and type value. When replacing an injector you need to find the corresponding model for replacement;***

***ⓘ At present, mainstream cars support injector coding functions.***

*The operation guidelines of the Injector Coding function are shown as below:*

1. Enter the **Injector coding** menu and choose relevant chassis models according to the vehicle being tested.
2. Enter the **Fuel injection nozzle injection volume adjustment** menu.
3. Read the note displayed carefully and press **OK** after the reading.

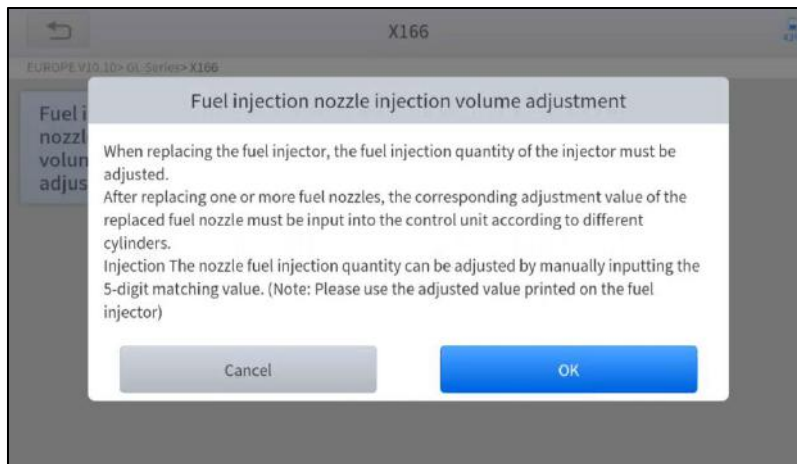

4. Read and confirm the value stored in the cylinders.

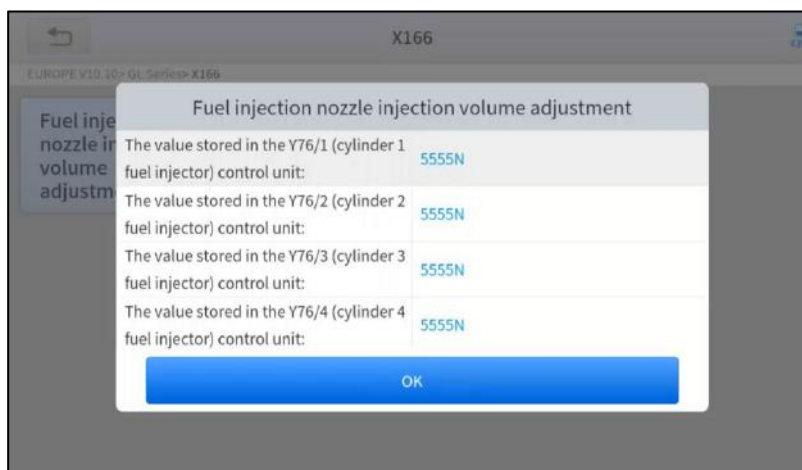

5. Enter the **Change the value of cylinder** menu of the replaced injector(s), enter the **new 5-digit value**, and then press **OK**.

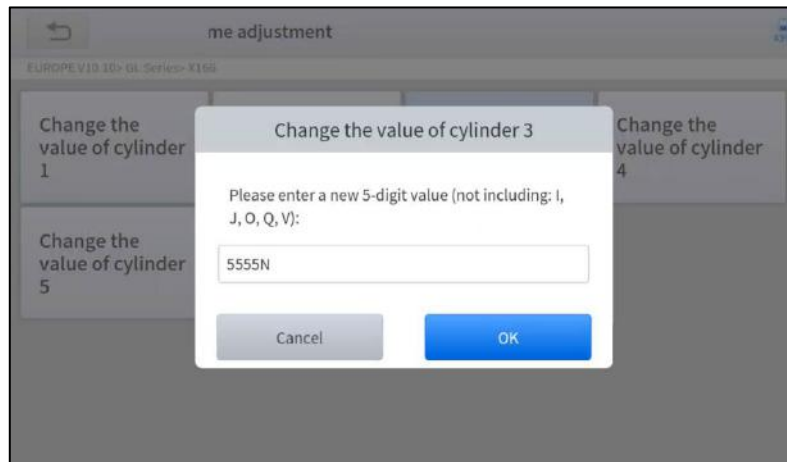

Wait until the message **'Write successfully'** pops up.

6. Turn off the ignition switch.
7. Wait until the message asks you to turn on the ignition switch.
8. Re-enter the **Fuel injection nozzle injection volume adjustment** menu to check whether the new value(s) are shown.

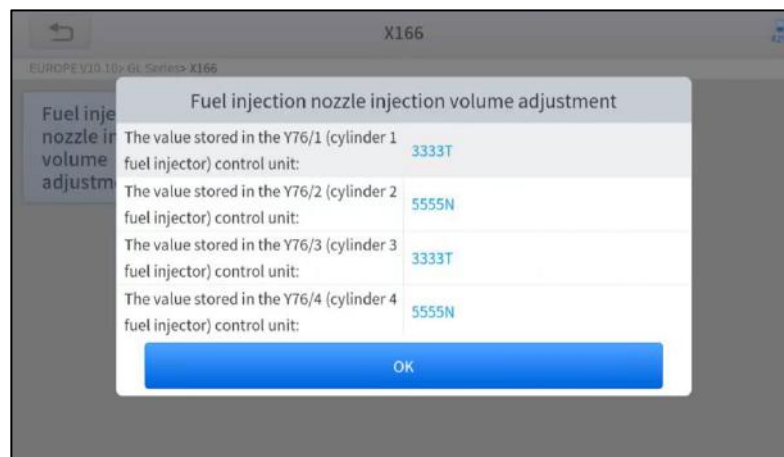

### **3.7 DPF REGENERATION**

The Diesel Particle Filter (DPF) function manages DPF regeneration, DPF component replacement teach-in, and DPF teach-in after replacing the ECM.

The ECM monitors driving style and selects a suitable time to employ regeneration. Vehicles driven a lot at idling speed and low load will attempt to regenerate earlier than vehicles driven more with higher load and speed. For regeneration to take place, a prolonged high exhaust temperature must be obtained.

In the event of the car being driven in such ways that regeneration is not possible, i.e., frequent short journeys, a diagnostic trouble code will eventually be registered in addition to the DPF light and “Check Engine” indicators displaying. A service regeneration can be requested in the workshop using the diagnostic tool.

DPF regeneration is used to clear PM (Particulate Matter) from the DPF filter through continuous combustion oxidation mode (such as high-temperature heating combustion, fuel additive or catalyst reduce PM ignition combustion) to stabilize the filter performance.

DPF regeneration may be performed in the following cases:

- The exhaust back pressure sensor is replaced.
- The PM trap is removed or replaced.
- The fuel additive nozzle is removed or replaced.
- The catalytic oxidizer is removed or replaced.
- The DPF regeneration MIL is on and maintenance is performed.
- The DPF regeneration control module is replaced.

*The operation guidelines of the DPF function are shown as below:*

1. Enter the **DPF** menu and choose relevant models according to the vehicle being tested.
2. Enter the **DPF regeneration** menu.
3. Read carefully and complete the **requisites** listed before performing the DPF regeneration function. Press **OK** after completing the instructions shown.

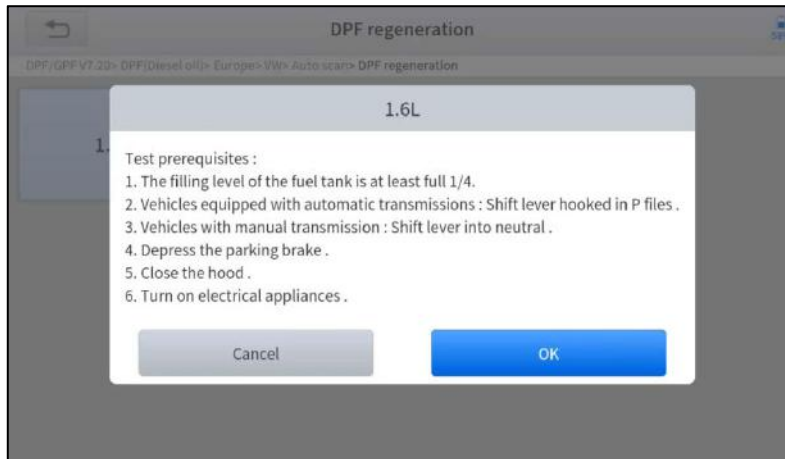

4. Read the fuel tank level and make sure that it fulfills the requirement displayed.
5. Read the carbon deposit load.
6. Choose the “drive to warm up” option and follow the instructions listed below. Press **OK** after completing the instructions shown.

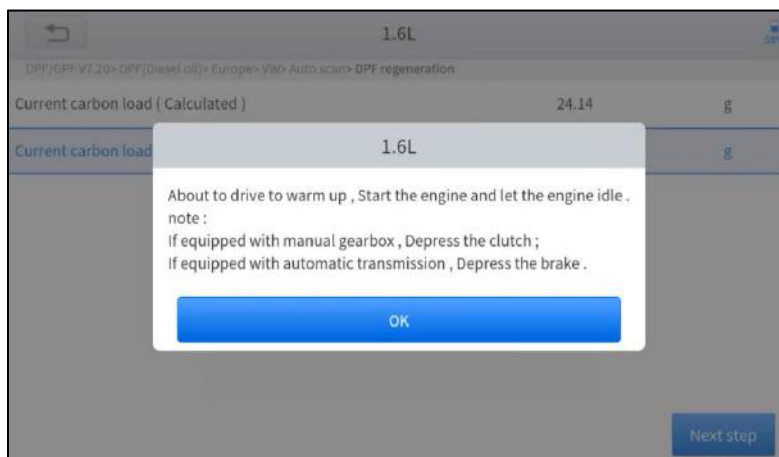

7. Read the instructions carefully and follow the instructions shown on the screen. Press **OK** after completing the instructions shown.

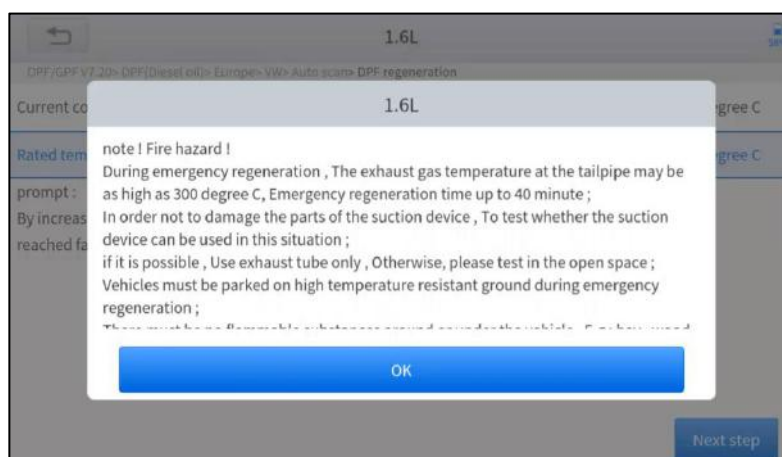

- Follow the instructions displayed and press **OK** after completing the instructions shown. **IMPORTANT:** Please pay attention to the Note.

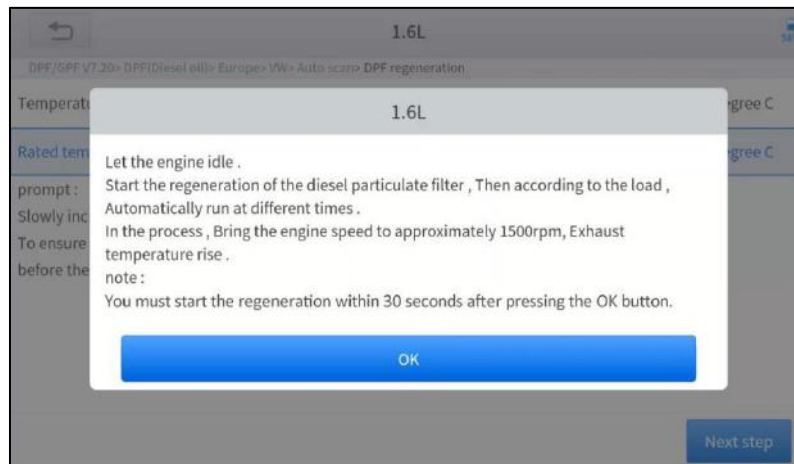

- Press the **OK** button to start the regeneration.

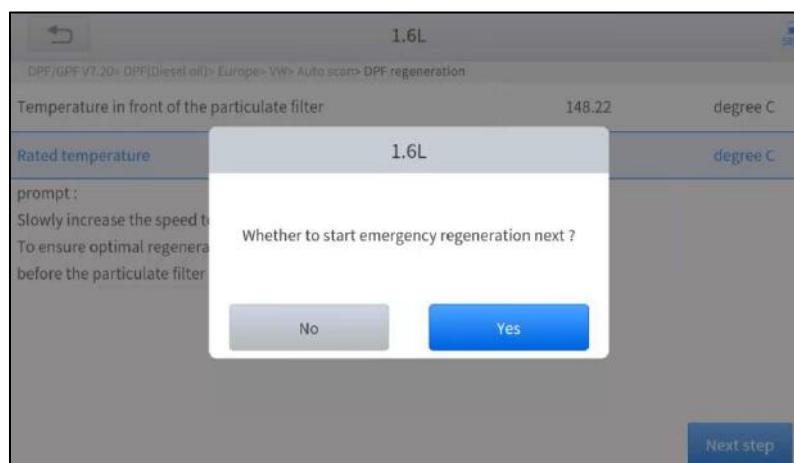

- Wait for the value of carbon deposit to decrease until a message of 'Emergency regeneration has been *completed*' pops up, this process may take up to 40 minutes.

1.6L		
DPF/GPF V7.20> DPF(Diesel oil)> Europe> VW> Auto scan> DPF regeneration		
Regeneration duration	0.00	min
Carbon deposit	22.78	g
Rotating speed	781	rpm
Waste temperature upstream of turbocharger	143.41	degree C
Upstream of particulate filter	143.21	degree C
Downstream of particulate filter	112.38	degree C
Next step		

11. Wait for **2 minutes** to let the particulate filter cool down.

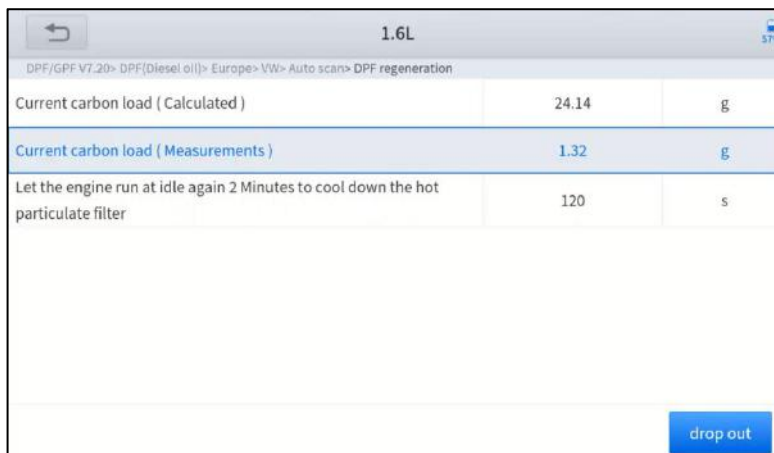

12. Press **drop out** to exit the DPF function.

### 3.8 TPMS RESET

This function allows to perform the learning and matching and resetting functions of the tire pressure sensor.

TPMS Reset may be performed in the following cases:

- Tire replacement
- After troubleshooting tire pressure related problems
- Other causes of loss of signal from the tire pressure sensor

1. For tire pressure sensor matching, some vehicle models may need the TPMS activation tool;
2. After learning process, you may need to run the car for some while before the fault light goes off;
3. Tire pressure imbalance may also cause the tire pressure light;

Even for the same model, its tire pressure system may differ by the region where it is manufactured. Therefore, under the TPMS Reset function, we provide 6 menus for the major automotive manufacturing regions, including **Korea, Japan, USA, China, Australia** and **Europe**, as shown below.

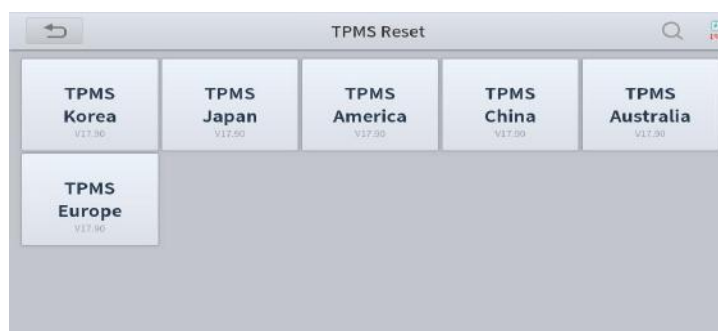

And then please enter the sub-menu by the origin region of car make and select the vehicle model you need



TPMS reset can be further divided into 4 methods, such as *Automatic Relearn*, *Static Relearn*, *Copy ID* and *OBD Relearn*, which is depending on the specific model. Also, even if the relearning methods are the same, the learning procedure may differ.

## ● AUTOMATIC RELEARN

1. Install tire pressure sensor appropriately
2. Adjust all TPMS sensors to the standard value
3. Keep the vehicle at a complete standstill status for more than 20 minutes (with the engine off and power off).
4. Drive at 30-100km/h for more than 15 minutes.
5. The vehicle will automatically relearn the value, after that, the tire pressure warning will disappear.
6. If the relearn procedure fails, please repeat steps 2-5 .

## ● STATIC RELEARN

1. Install all tire pressure sensors appropriately.
2. Pull up the parking brake.
3. Turn the ignition to ON/RUN with **the engine off**.
4. Enter the tire pressure learning mode through the instrument panel on vehicle. There will be the corresponding prompt, which are differ from different car make and model, please subject to the vehicle manual or consult a professional)
5. Starting from the left front wheel (some models flash the turn signal at the corresponding position), use the TPMS Activation Tool to activate the sensor, and the vehicle will sound the horn or flash the turn signal at the corresponding position after successful activation.

**Note: The first sensor should be learned within 2 minutes, otherwise please repeat step 4**

6. After the left front wheel sensor is successfully relearned. For the remaining, please activate the remaining tire pressure sensors in the order of right front, right rear and left rear. The prompt and activation success status are the same as step 5

**Note: The remaining sensor learning needs to be completed within 3 minutes, otherwise please repeat the relearn procedure from step 4!**

7. Turn the vehicle off and power off. Adjust all sensors to the standard value.
8. Tire pressure warning light will disappear after success. If procedure fails, please repeat steps 4-7

### ● **OBD RELEARN**

1. A TPMS Activation Tool is needed
2. Install tire pressure sensor appropriately
3. Adjust all TPMS sensors to the standard value
4. Activate all sensors in the order of left front, right front, right rear, left rear
5. Connect TPMS Activation Tool to the OBD port of vehicle and perform the OBD relearn function to write the sensor ID
6. Turn the ignition to **ON/RUN**, re-trigger all sensors in the order of left front, right front, right rear, left rear
7. Keep the vehicle powered off for more than 25 minutes
8. Drive at 30-100km/h for more than 15 minutes. If relearn successful, the tire pressure warning light will go off. Otherwise, please repeat steps 4-7

### ● **COPY ID RELEARN**

**Note: This learning method of the vehicle can only copy ID to the new sensor through the following three methods to replace the original sensor, if the new sensor cannot change its own ID, then the sensor can only be replaced by the OEM equipment!**

#### **Method 1:**

1. Use a TPMS Activation Tool to activate the original sensor, copy the sensor ID to the tire pressure activation device
2. And then program the copied ID into the new sensor through the TPMS Activation Tool (The binary of ID format should be the same as the original sensor)
3. Remove the original sensor that has been just copied the ID, install the new sensor that has just been programmed, and put the tire back on

#### **Method 2:**

1. Use the TPMS Activation Tool to connect the vehicle OBD port, enter the tire pressure system, copy the ID of the sensor to be replaced
2. And then program the copied ID into the new sensor through the TPMS Activation Tool (The binary of ID format should be the same as the original sensor)
3. Remove the original sensor that has been just copied the ID, install the new sensor that has just been programmed, and put the tire back on

#### **Method 3:**

1. Remove the original sensor
2. Use the TPMS Activation Tool to copy the original sensor ID into the new sensor manually (The binary of ID format should be the same as the original sensor)
3. Install the new sensor to the tire correctly, set the tire pressure to the standard value, and put the tire back on the vehicle

**Note**

- a) Tire pressure standard is usually displayed in these places:
  - Vehicle owner's manual
  - Label next to the driver's door (near the B-pillar)
  - Drawer next to the driver's seat of the vehicle
  - Fuel tank cap
- b) This Scan Tool **is not a replacement for the TPMS activation tool, and it only provide TPMS Reset/Relearn function but activation of TPMS sensors.** If you need a professional TPMS activation tool, please consult your local dealer.

## 4. REPORT

Diagnostic Report is used for viewing and printing the saved files, such as Live Data, Trouble codes or pictures generated in the process of diagnosis.

Users also can view a record of which cars have been previously tested. It includes 3 parts:

- **Diagnosis Report**
- **Data Playback**
- **Data View**

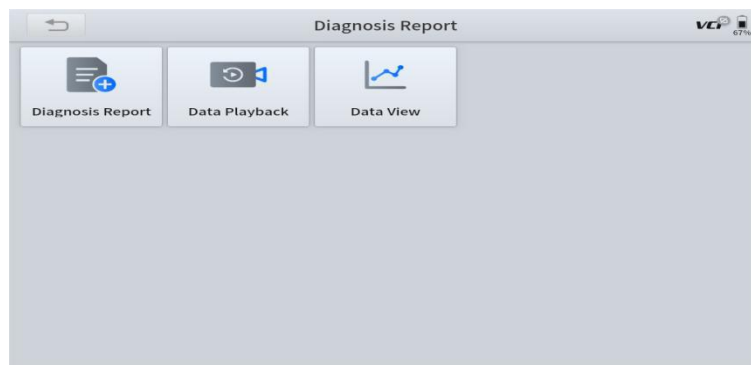

## REPORT

This feature provides a history of diagnostic reports, where you can view and delete the vehicle's diagnostic reports according to your needs.

When you finish the diagnostics progress and exit the diagnostic application specific to this vehicle, you will get a prompt of report regeneration.

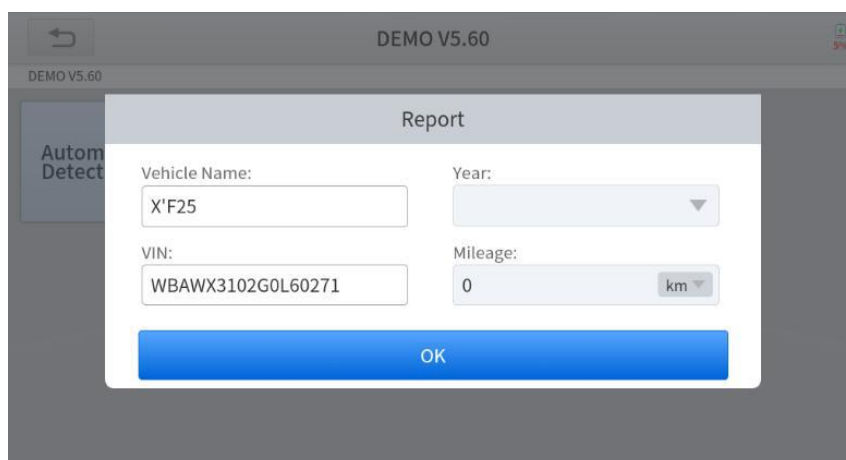
A screenshot of a "Report" dialog box. The dialog box is titled "Report" and is overlaid on a background that says "Autom Detect". The dialog box contains four input fields: "Vehicle Name:" with the text "X'F25", "Year:" with a dropdown arrow, "VIN:" with the text "WBAWX3102G0L60271", and "Mileage:" with the text "0" and a "km" dropdown arrow. At the bottom of the dialog box is a large blue button labeled "OK". The background application shows "DEMO V5.60" at the top and "Autom Detect" on the left side.

Report	
GM 2021-05-15 10:59:36	Delete
日产 2021-05-12 16:18:37	Delete
DEMO 2021-05-12 14:31:24	Delete

When you open the report, located in the header of the table is the workshop information you filled in advance in the system setup, then the information of the vehicle, as shown below:

**Note: The vehicle information is allowed to edit by clicking the pen icon on the right side of the picture shown above.**

You also can click "**Print PDF Report**" at the bottom right corner to output the pdf report. If you need to close the report tap on the button "**Exit**".

Please follow the below steps to print your report ▼

**Step 1:** Install an APP that can connect to your target printer. Add the printer and input the IP address of the printer in the APP, or you can contact the XTOOL support team ([support1@xtooltech/](mailto:support1@xtooltech.com) [support2@xtooltech.com](mailto:support2@xtooltech.com)) for help.

**⚠ The Scan tool doesn't provide the printer driver software, please install a third part App on the tablet if you need the print your Diagnostic report.**

**Step 2:** On the Android main menu, go to Settings -> Printing-> Turn printer on.

**Step 3:** Report-> Choose report-> Print PDF Report-> Print

**Step 4:** Click the top-left corner of the screen and choose the printer previously added. Then click the button on the right to print.

## REPLAY

This function allows you to replay the living data recorded during the Diagnostic process.

Before replaying the living data, please make sure you have recorded the live data during the Diagnostic



The screenshot shows the 'Data Playback' interface displaying a table of recorded data. The table has columns for NO., Name, Value, and Unit. A play button is visible at the bottom of the table.

NO.	Name	Value	Unit
1	Speed reading	0.00	km/h
2	Total distance (instrument cluster display) (conversion factor km/1.6 = mile)	40352	km
3	Revolution counter	840	1/min
4	Outside temperature sensor	50.00	deg C
5	Total distance (absolute value)	40356	km
6	Fuel level sensor, right	23.00	l

## Data View

Here to view the saved live data in different ways.

## 5. UPDATE & FACTORY RESET

### UPDATE

After activating the device, please **update** the software modules identified in the "Updates" screen. The device will identify all currently available software packages, and you can download them as needed. ALL software updates directly via the Internet. To access the update application, open the Diagnostic application and click Updates to enter the screen shown below:



1	IMMOBILIZER--LANCIA	V26.92	2021-02-22 00:44:06	—————	↑
2	IMMOBILIZER-- SUBARU	V26.53	2020-12-11 01:02:55	—————	↑
3	IMMOBILIZER-- QNLOTUS	V26.20	2017-01-16 21:47:47	—————	↑
4	IMMOBILIZER--DODGE	V27.02	2020-11-19 00:51:17	—————	↑
5	IMMOBILIZER-- BENTLEY	V28.03	2020-11-23 05:58:28	—————	↑
6	DIAGNOSIS--BYD	V10.00	2020-09-30 01:22:49	—————	↑

Update All

**⚠ After contacting your XTOOL Support to change the language configuration, you need to download all the software packages on the device again.**

### Cautions

When the subscription expires, the software has installed on your device itself still is available, but all updates will be invalid. If you delete specific software due to the personal operation, XTOOL is not responsible for supporting the restoration of the software when the subscription expires.

To renew your subscription, please contact your local dealer, or contact XTOOL technical support team directly.

## FACTORY RESET

When you choose to restore factory settings in the Android OS system, the device will automatically erase any custom settings and data, restart and then enter the factory reset mode.

A **factory reset** is triggered by clicking the Settings mode from the main home page, and then clicking on “Backup & reset”. Follow onscreen prompts to initiate the factory reset process.

Once the scan tool resets to factory default settings it will start up and then you can select the language in the following interface.

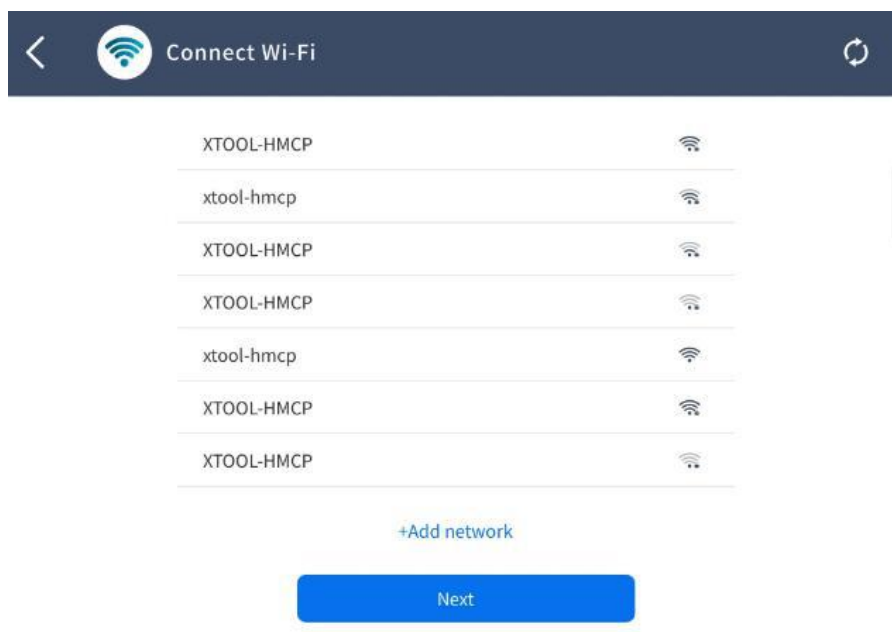
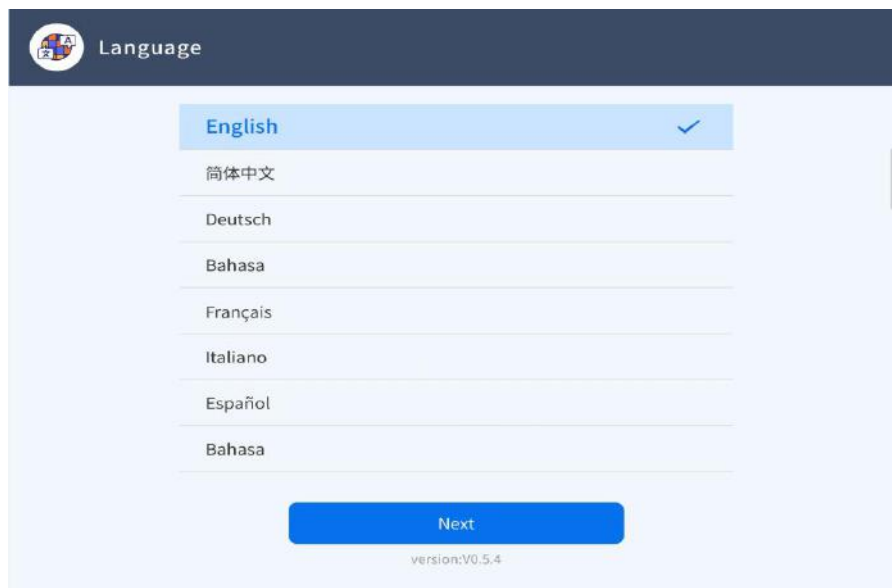

## 6. REMOTE ASSISTANCE

Tap on "Remote" to start the TeamViewer quick support program, which is a simple, fast, and secure remote-control screen. You can use this application to enable someone else to use their computer running TeamViewer software to control your tablet over the Internet. This feature is frequently used by XTOOL's technical support centre when remotely helping customers with technical support.

Computers and mobile devices running TeamViewer are identified by a globally unique ID. When the remote application is started for the first time, the ID will be automatically generated according to the hardware characteristics and will not be changed in the future. This TeamViewer ID can individually access all TeamViewer clients.

Before launching the remote desktop application, make sure that the tablet is connected to the Internet so that you can access the tablet to receive remote support from a third party. If you encounter problems and are not able to solve them, you could open this application and ask for remote assistance.

To obtain remote support from your partners or XTOOL AfterSalesService Center:  
support1@xtooltech.com | support2@xtooltech.com

1. Turn on the power of the tablet.
2. Click Remote in the Diagnostic application. The TeamViewer screen is displayed, and the device ID will be generated.
3. Your partner must install the remote-control software on their computer by downloading the full version of the TeamViewer program (<http://www.teamviewer.com>) online, and then start the software on their computer at the same time, to provide support and remote control of the tablet.
4. Provide your ID to the partner or XTOOL technician, and then wait for them to send you a remote-control request.
5. A pop-up window will be displayed, asking you to permit the remote-control program to control your device.
6. Click Allow to accept, or click Reject to reject.

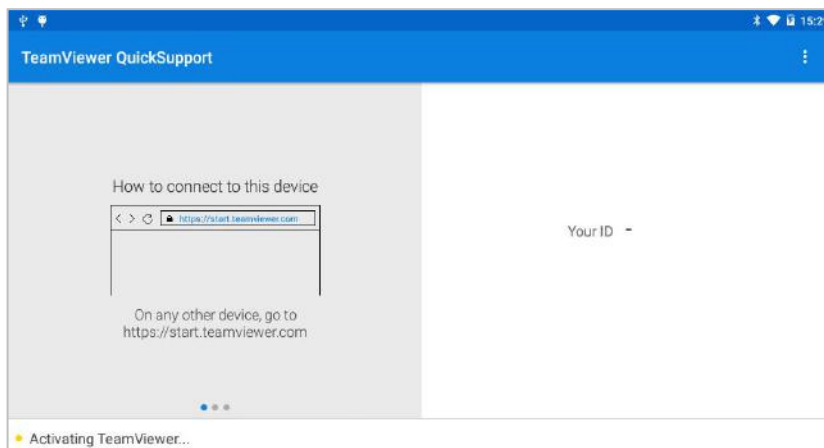

## 7. APPENDIX

### DTC STATUS DESCRIPTIONS

DTC Status	Descriptions	Suggestions
Current /Present	Current DTC's are trouble codes that are stored in the ECU when both continuous and non-continuous (2 trip) monitors fail. Current DTC's command the MIL On the instant they are stored in the ECU.	Current DTC's can be cleared using the Clear DTC's function of the Scantool, or when the ECU monitor (2 trip monitor) has ran and completed 40 consecutive trips without a fault.
History/Stored	History DTC's are trouble codes stored in the ECU when continuous and non-continuous monitors (2nd trip) fail. History DTC's set in conjunction with Current DTC's and are not cleared by the ECU monitor. History DTC's can only be cleared using the Clear DTC function of the Scantool.	History DTC's set in conjunction with Current DTC's and are not cleared by the ECU monitor. History DTC's can only be cleared using the Clear DTC function of the Scantool.
Pending	Pending codes are codes that prep themselves when they determine a fault that engine cycle. They are basically a preliminary investigation for your engine. To simplify, a random malfunction can occur during the current drive cycle but only happen for a split second. This will cause the malfunction to throw a "pending code".	Typically pending codes are not to severe but you shouldn't ignore them either, it can be cleared using the Clear DTC's function of the Scantool
Permanent	Permanent DTC's are trouble codes that are stored in the ECU when continuous and non-continuous monitors fail. Permanent DTC's are set in conjunction with Current and History DTC's.	Permanent DTC's cannot be cleared using the Clear DTC's function on the Scantool. Instead, Permanent DTC's are cleared when the ECU monitor completes and passes three consecutive trips.
<b>For Volkswagen</b>		
Active/static	Active/Static means that the fault is happening at the moment and can/should be take care of.	The fault cannot be cleared directly by using the Clear DTC's function of the diagnostic tool and the internal fault of the car must be eliminated manually
Passive/sporadic	It is a fault that has occurred in the past and can be cleared by Scantool, and user should to check if the DTC will appear again.	/

## 8. KEY PROGRAMMING

The key programming software inside X100PADS app can get access to the immobilizer system inside the vehicles and supports multiple functions like key programming, generate dealer key, all key lost, immobilizer reset or changing, EEPROM chip coding and much more.

### KC501 CONNECTION

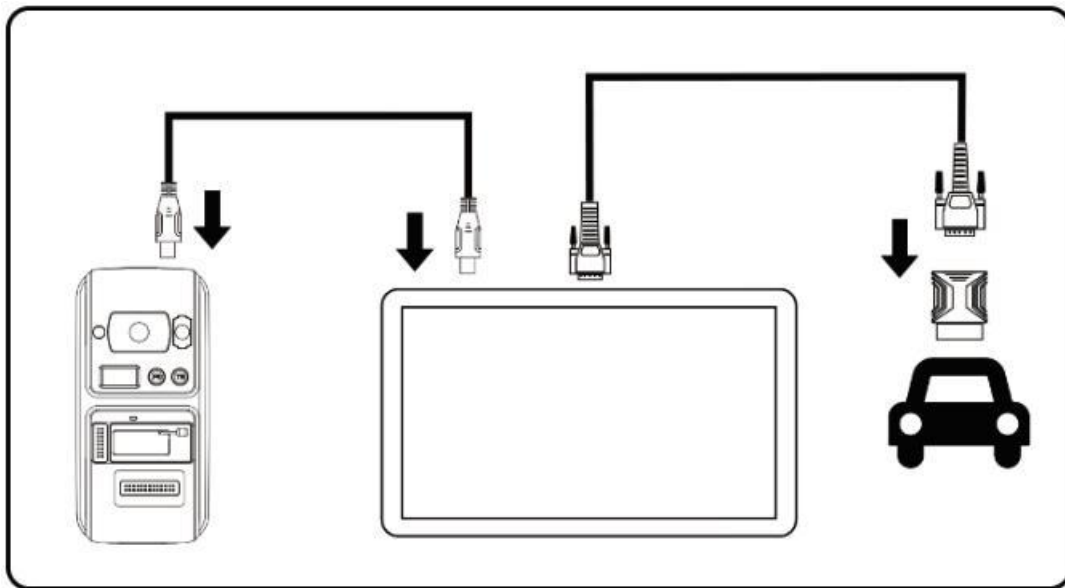

- a. Turn on the device.
- b. Power up the VCI box with vehicle connection or 12V power input. When programming keys, vehicle connection is necessary.
- c. Connect the device and the KC501 using the USB cable.

# MENU



① For different models with different immobilizer modules, the key programming process will be completely different. Most of the process could be done by following the instructions on the screen. But if you are not sure how to do that, please check the tutorials.

① If you need to check if your car is supported, you can click the PDF icon at the top right of the model brand button.

# COMMON IMMOBILIZER FUNCTIONS

## READ PIN CODE/PIN CODE CALCULATION

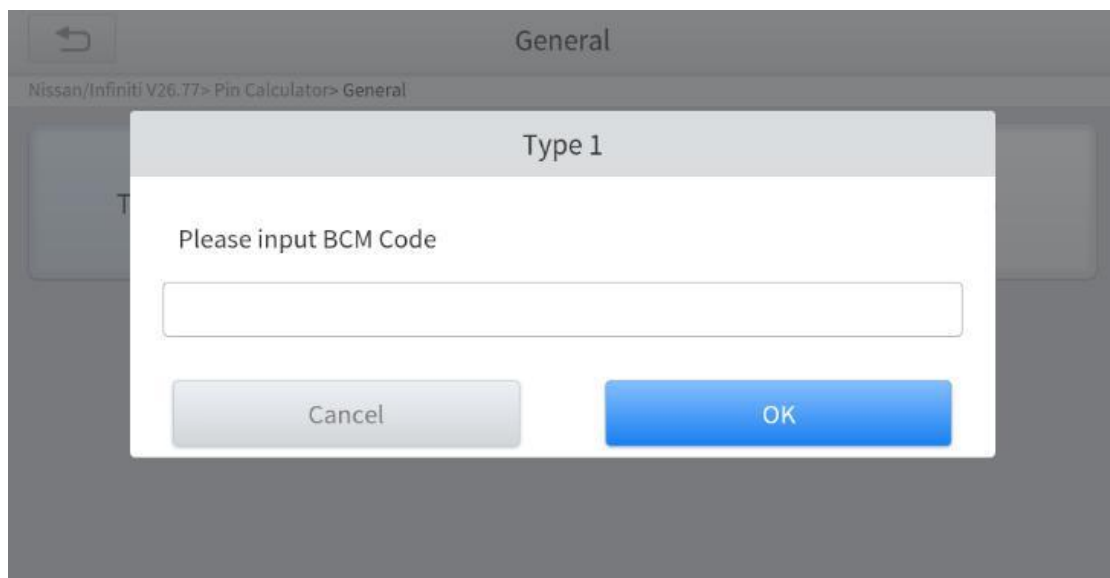

After you inserted the code, the results will show up.

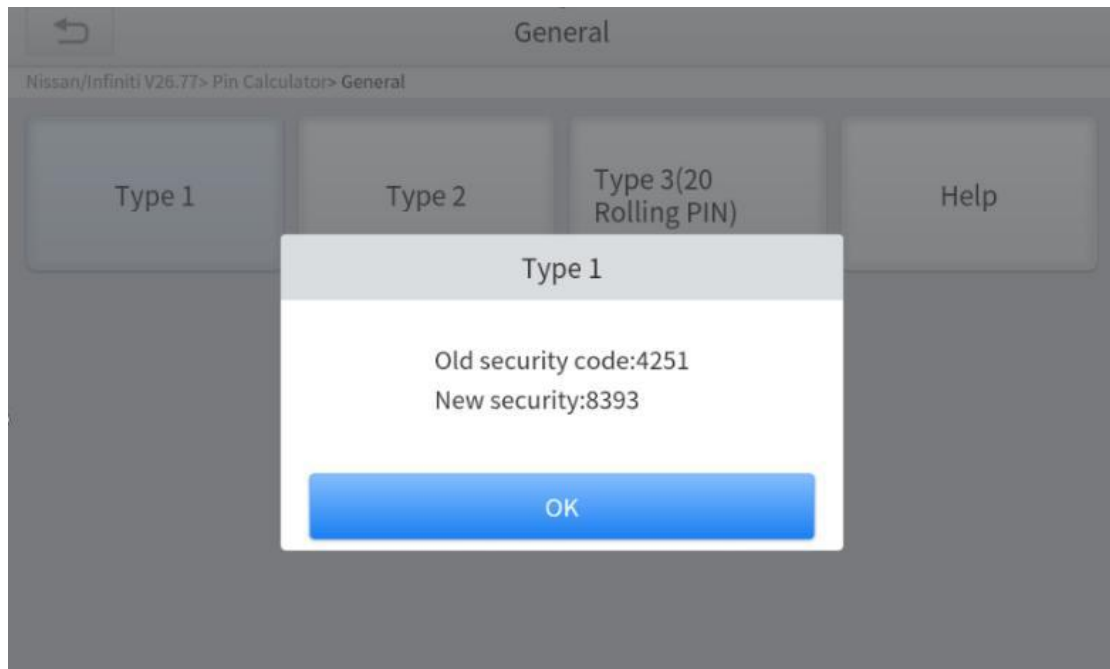

## **CHECK NUMBER OF KEYS**



Click “Number of keys” and it will show the number of the keys that are registered to the vehicle.

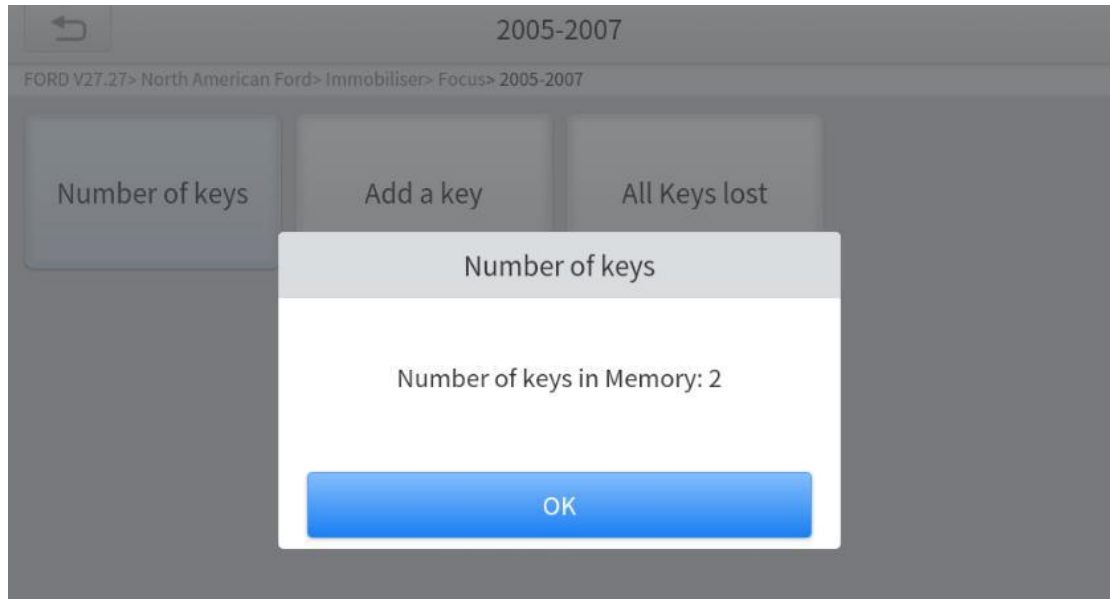

## ADD KEYS

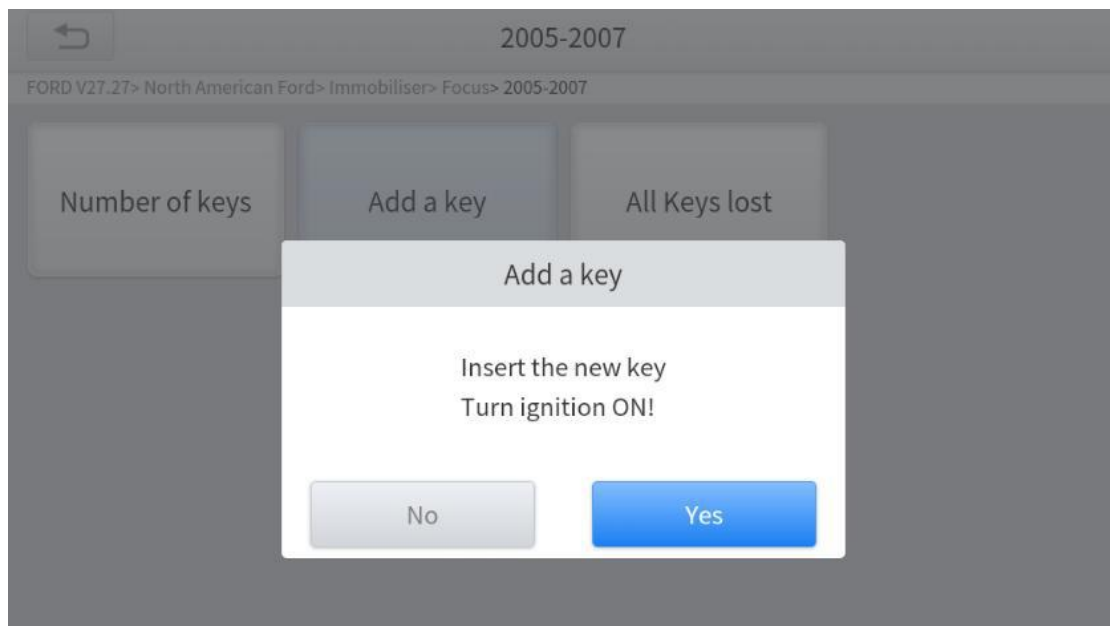

You can choose “Free-wait mode” to bypass the security access, or you’ll need to wait for about 10 minutes. We choose “Yes” here.

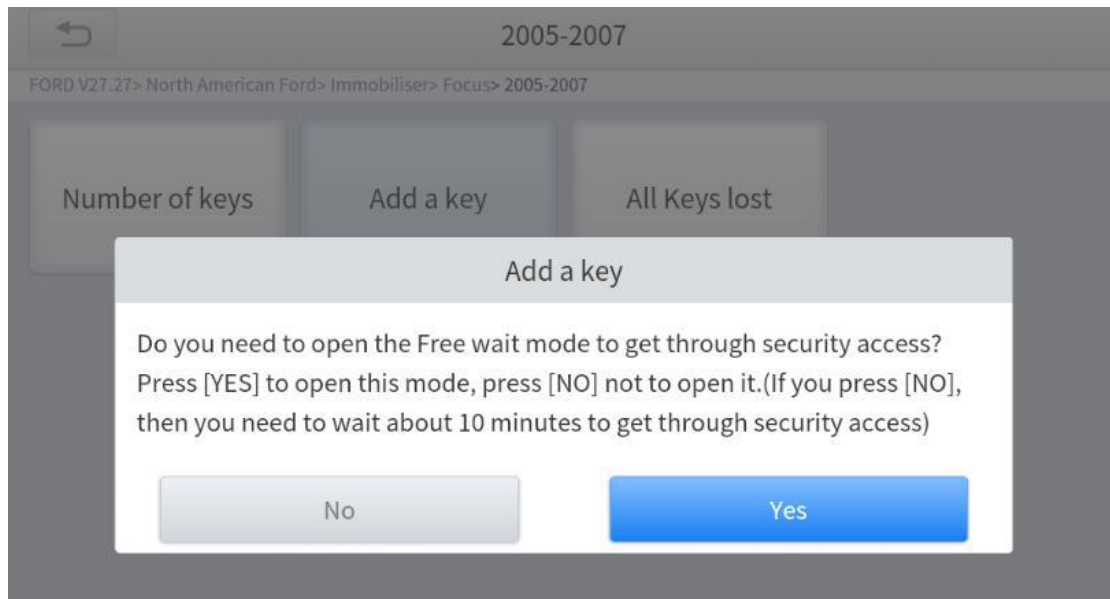

Wait for a while until it shows the results.

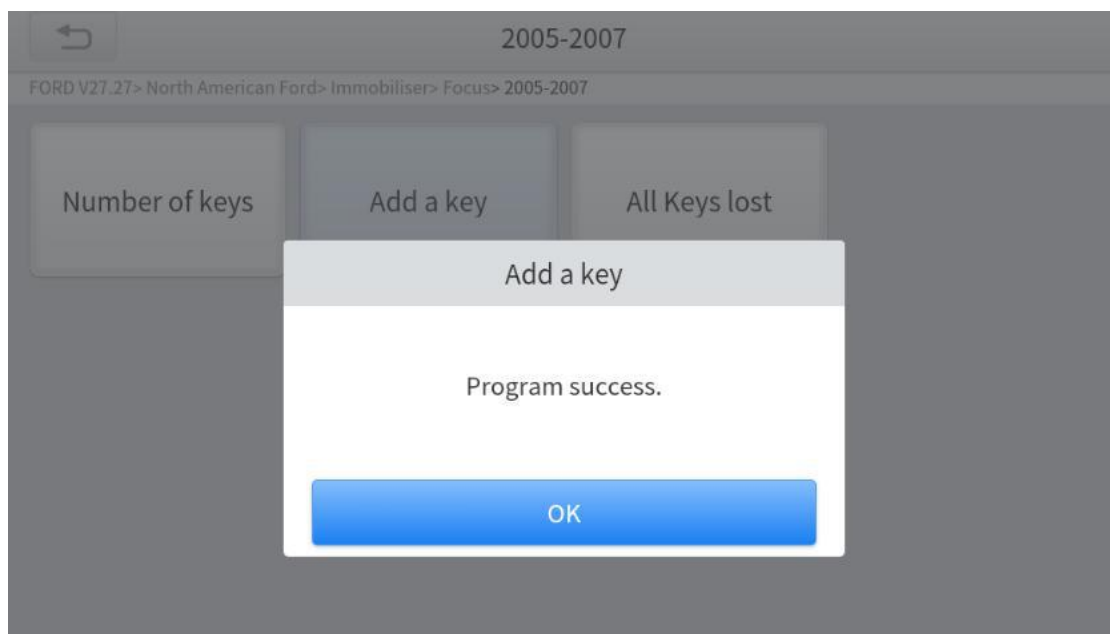

## ALL KEY LOST

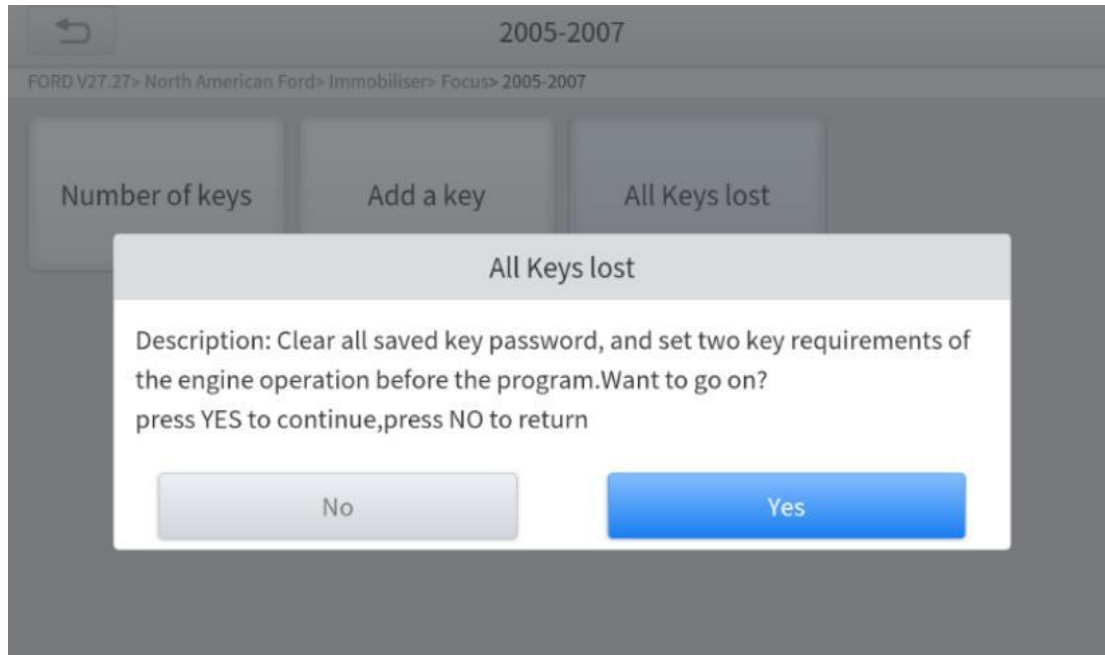

This also has a “Free-wait mode”, click “Yes” here.

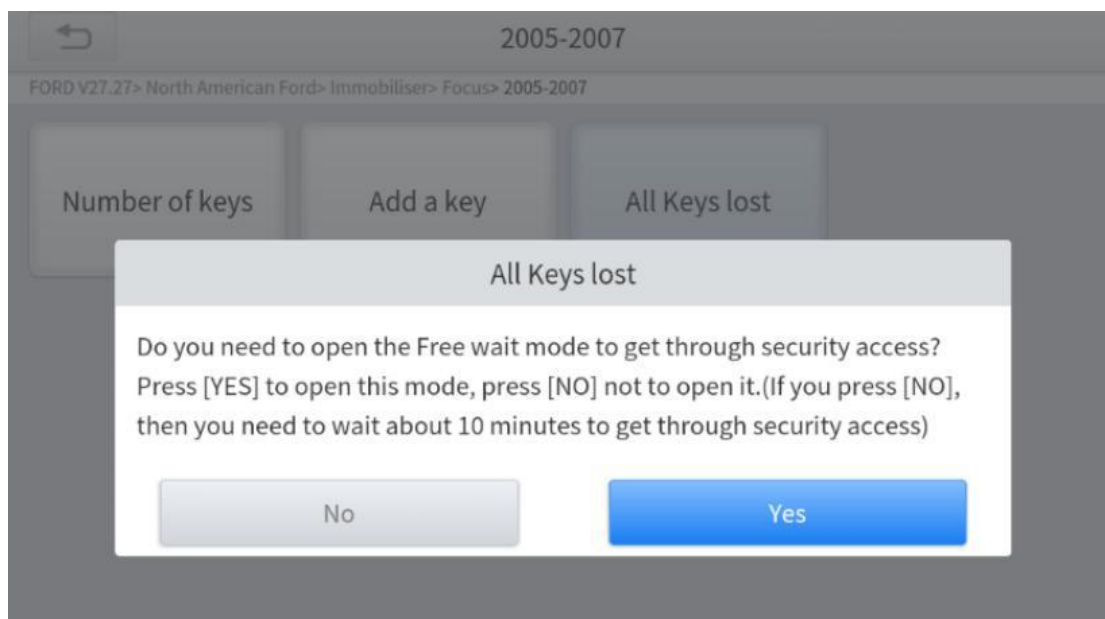

Wait a while until the results shows up.

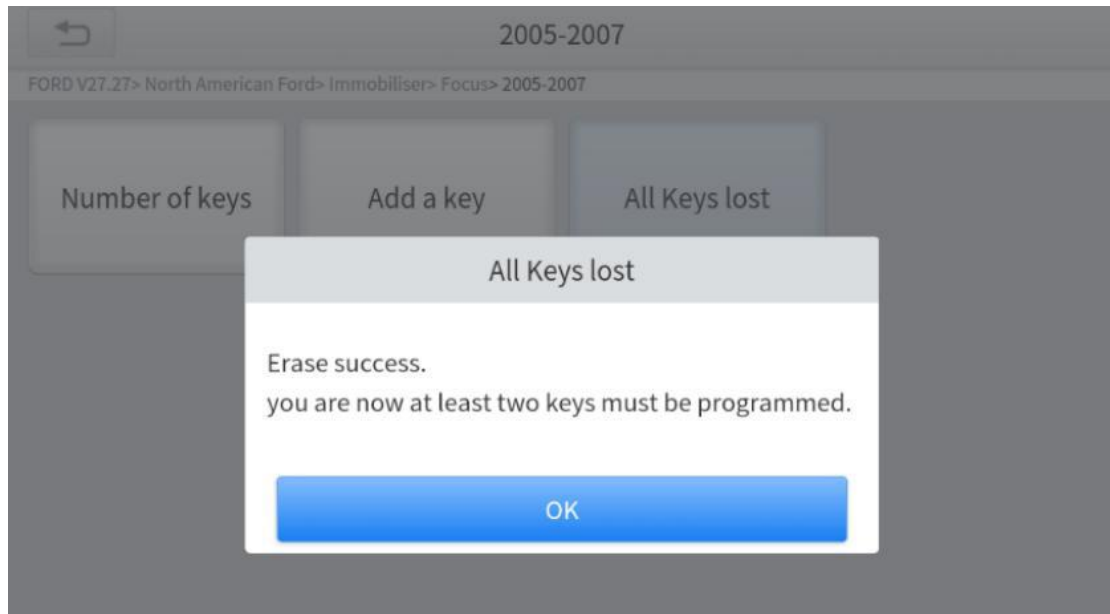

After successfully reset, please insert two new keys into the ignition switch and turn them on one by one.

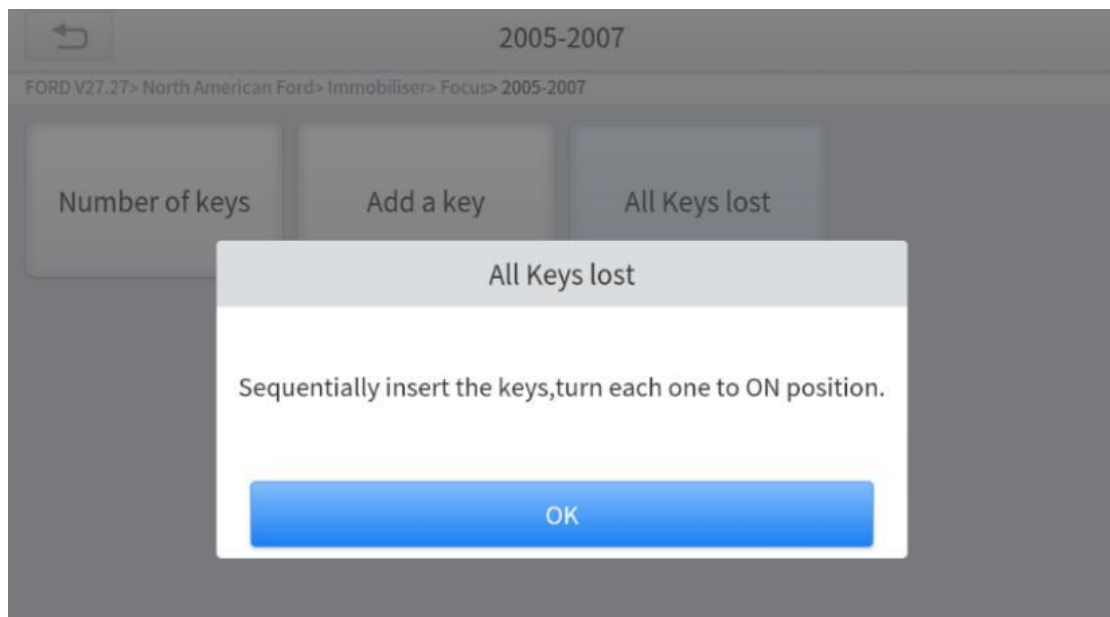

① We suggest checking all the keys every time after you programmed the key.